

nox medical

NOX T3_s

MANUAL

Nox T3s US Manual

Version 2.2

Latest Revision: 2025-01

Copyright © 2025

Nox Medical – All rights reserved

Manufactured by:

Nox Medical ehf

Katrinartuni 2

IS – 105 Reykjavik

Iceland

Website: www.noxmedical.com

nox medical

For distributor information go to:

www.noxmedical.com

Copyright Notice

No part of this publication may be reproduced, transmitted, transcribed, stored in a retrieval system, or translated into any language or computer language, in any form, or by any means: electronic, mechanical, magnetic, optical, chemical, manual, or otherwise, without the prior written authorization from Nox Medical.

License Notice

The Nox T3s recorder's firmware contains BIGDIGITS multiple-precision arithmetic code originally written by David Ireland, copyright © 2001-8 by D.I. Management Services Pty Limited <www.di-mgt.com.au>, and is used with permission.

Table of Contents

Table of Contents 3

List of Abbreviations 5

Introduction..... 6

 Intended Use..... 6

 Contraindications..... 6

 Scope 6

 Warnings and Cautions for Use 7

 Instructions for Operators 9

Nox T3s Description..... 10

 Nox T3s Interface 10

Operating Nox T3s 12

 Connecting Nox T3s to a Computer 12

 Configuring and Downloading from Nox T3s 12

 Starting/Stopping by Connecting RIP belts on Nox T3s 12

 Starting/Stopping by Pressing Button on Nox T3s (manual)..... 13

 Starting Nox T3s at a Scheduled Time 13

 Nox T3s Status 14

Nox T3s Patient Hookup 17

 Inserting a Battery to the Nox T3s 17

 Attaching the Nox T3s and the Nox RIP Belts 18

 Attaching the Nox Nasal Cannula 20

 Measuring Mask Pressure..... 21

 Measuring ExG Signals 22

 Measuring Pulse and Oxygen Saturation using Nonin 3150 BLE Pulse Oximeter 22

 Inserting Batteries into the Nonin 3150 BLE Pulse Oximeter 23

 Selecting Oximeter Sensor Size..... 24

 Attaching the Nonin 3150 BLE Pulse Oximeter and Soft Sensor..... 24

Establishing a Connection between the Nonin 3150 BLE Pulse Oximeter and Nox T3s	26
Maintenance.....	31
Compatible Sensors and Devices.....	34
Specifications.....	38
Nox T3s and Accessories.....	38
Material Information	40
Security Information.....	41
Nox T3s Recorder Ecosystem / User Environment	41
Ambulatory Setup	41
Data At Rest	41
Data In Transit.....	41
Security Updates	42
Vulnerabilities	42
Software Bill of Materials (SBOM)	42
Decommissioning.....	42
Regulatory Information	43
Performance Testing and Validation Summary	43
Nox T3s Classifications.....	43
Description of Symbols and Labels	44
Bluetooth® Wireless Technology	46
Electromagnetic Compatibility (EMC) Information.....	46

List of Abbreviations

ABS	-	Acrylonitrile Butadiene Styrene
BMI	-	Body Mass Index
CISPR	-	<i>Comité International Spécial des Perturbations Radioélectriques</i> (English: International Special Committee on Radio Interference)
ECG	-	Electrocardiography
EEG	-	Electroencephalography
EMG	-	Electromyography
EMC	-	Electromagnetic compatibility
EOG	-	Electrooculography
ESD	-	Electrostatic discharges
FCC	-	Federal Communications Commission
FDA	-	Food and Drug Administration
HF	-	High Frequency
IEC	-	International Electrotechnical Commission
ISM	-	Industrial, Scientific and Medical
MRI	-	Magnetic Resonance Imaging
NiMH	-	Nickel-metal hydride battery rechargeable
PAP	-	Positive Airway Pressure
PC	-	Polycarbonate
PET	-	Polyethylene Terephthalate
PE	-	Polyethylene
PID	-	Product Identification
PII	-	Personal Identifiable Information
PVC	-	Polyvinyl Chloride
RF	-	Radio Frequency
RIP	-	Respiratory Inductance Plethysmography
SpO2	-	Oxygen Saturation Levels measured by pulse oximetry
TPE	-	Thermoplastic Elastomer
VID	-	Vendor Identification

Introduction

Congratulations on choosing the Nox T3s™ recorder. The Nox T3s is an ambulatory body worn sleep recorder and is a part of the Nox T3s system. Its main function is to record physiological signals during sleep by use of built-in sensors and patient applied sensors. The Nox T3s recorder has a built-in Bluetooth® module also allowing it to record signals from compatible auxiliary devices. Placement of the recorder and connecting sensors is simple and makes the setup quick and easy. The Nox T3s recorder is configured by the Noxturnal US software from Nox Medical, running on a PC that also allows for the review, organization, analyzing, and summarizing of all signals recorded by the device. The complexity of the study is defined by varying the number and types of physiological signals measured.

Intended Use

The Nox T3s recorder is intended for ambulatory recording of physiological signals during sleep. The recorded signals are then downloaded to a PC where the signals can be viewed and analyzed by use of the Nox T3s application (Noxturnal US). The Nox T3s recorder is intended for patients greater than 2 years of age.

The intended environments are hospitals, institutions, sleep centers, sleep clinics, or other test environments, including the patient's home.

Contraindications

The Nox T3s recorder is **NOT** intended for any patient monitoring or automatic diagnosis.

Scope

This manual covers the use of the Nox T3s recorder and its components along with external sensors and auxiliary devices that have been validated with the Nox T3s system. The Nox T3s Recorder is a new variant of the Nox T3 Recorder.

The use of the Nox T3 Recorder and its components along with external sensors and auxiliary devices that have been validated with the Nox T3 System is covered in:

- Nox T3 US Manual

The picture below shows the different appearance of the Nox T3 Recorder and the Nox T3s Recorder. Please be sure you are following the correct manual for your recorder.

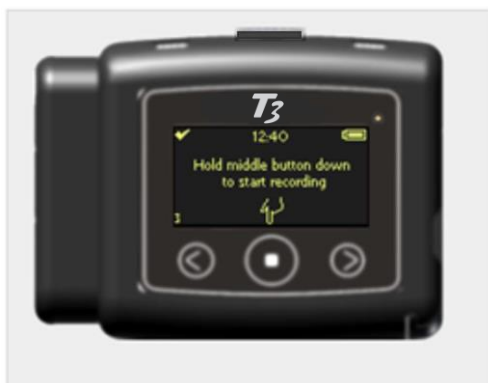

Nox T3 Recorder



Nox T3s Recorder

The use of the Noxturnal US software application that is needed for device configuration, data download, review, and analysis is covered in:

- Noxturnal US Manual

This manual is only intended for professionals (healthcare professionals and service personnel) with relevant qualifications and skills. Hookup instructions are available on the Nox Medical Support Site for self-application by the patient.



- ▶ Note: Additional material can be found on the Nox Medical Website, www.noxmedical.com

Warnings and Cautions for Use

- ▶ Warning: The Nox T3s System is **NOT certified to be used for continuous monitoring** where failure to operate can cause injuries or death of the patient.
- ▶ Caution: U.S. federal law restricts this device to sale by, or on the order of, a licensed medical practitioner.
- ▶ Caution: The Nox T3s recorder complies with the international standard IEC 60601-1-2 for electromagnetic compatibility for medical electrical equipment and/or systems. That standard is designed to provide reasonable protection against harmful interference in a typical medical installation. However, because of the proliferation of radio-frequency transmitting equipment and other sources of electrical noise in healthcare and other environments, it is possible that high levels of interference due to close proximity or strength of source might disrupt the performance of the device, affecting recorded signals and therefore data analysis and resulting in possible incorrect treatment. Medical electrical equipment needs special precautions regarding Electromagnetic Compatibility (EMC), and needs to be installed and put into service according to the EMC information detailed in the section “Electromagnetic Compatibility (EMC) Information” of this manual.
- ▶ Warning: The use of accessories, transducers, sensors, and cables other than those listed in this manual may result in increased emissions and/or decreased immunity of the Nox T3s System and cause injuries to the operator/patient.
- ▶ Warning: The Nox T3s recorder(s) should not be used adjacent to or stacked with other equipment. If adjacent or stacked use is necessary, the device(s) should be observed to verify normal operation in the configuration in which it will be used and prevent abnormal operation which might cause injuries to the operator/patient.
- ▶ Caution: Exposure to radio frequency radiation.
- ▶ Warning: External equipment and all auxiliary devices intended for connection to signal input, signal output or other connectors shall comply with the relevant product safety standards, e.g. IEC 60950-1 for IT equipment and the IEC 60601 series for medical electrical equipment, to prevent electric shocks. In addition, all such combinations – systems – shall comply with the safety requirements stated in the general standard IEC 60601-1, edition 3/3.1/3.2, clause 16. Any equipment not complying with the leakage current requirements in IEC 60601-1 shall be kept outside the patient environment, i.e. at least 1.5 m from the patient support. Any person who connects external equipment to the signal input, signal output or other connectors has formed a system and is therefore responsible for the system to comply with the requirements. If in doubt, contact a qualified medical technician or your local representative.

- ▶ **Caution:** The Nox T3s recorder is designed to be safe for use for pacemaker patients if the pacemakers comply with the standard: EN 45502-2-1 Active implantable medical devices. Particular requirements for active implantable medical devices intended to treat bradyarrhythmia (cardiac pacemakers) and/or EN 45502-2-2 Active implantable medical devices. Particular requirements for active implantable medical devices intended to treat tachyarrhythmia (includes implantable defibrillators). Using non-compliant pacemakers may result in the operation of the pacemaker being affected by the use of Nox T3s recorder and lead to possible patient harm. Prior to using the device with pacemaker patients, the operator should consult the accompanying documents of the pacemaker regarding its certifications and requirements of use or, if necessary, contact the manufacturer.
- ▶ **Warning:** Do not use the Nox T3s recorder and accessories during radiography/X-ray studies. The energy absorption in the device, cables or electrodes might lead to excessive heating and cause burns.
- ▶ **Warning:** The Nox T3s recorder and accessories are not intended to be used with high frequency (HF) equipment. Using the device with high frequency (HF) equipment could cause potential serious harm to the patient.
- ▶ **Warning:** The Nox T3s recorder is not defibrillator proof. Not removing the device from a patient before defibrillation may lead to the creation of high current density at the electrode sites, causing burns and leading to possible patient harm. Not removing the device from a patient before defibrillation may also alter the intended flow of the current, affecting the defibrillation efficiency and causing injuries or death of the patient.
- ▶ **Warning:** Do not use any part of the Nox T3s System, including patient cables and electrodes, in a Magnetic Resonance Imaging (MRI) environment. The energy absorption in conductive materials might lead to excessive heating and cause burns.
- ▶ **Caution:** The Nox T3s recorder and Nox RIP belts should be worn over clothing to prevent allergic reaction to the equipment materials.
- ▶ **Warning:** Avoid accidental contact between connected but unused patient applied parts and other conductive parts including those connected to protective earth to prevent potential serious harm to the operator/patient.
- ▶ **Warning:** Do not use damaged equipment, sensors or accessories. This may result in bad performance of the Nox T3s System or patient/operator injury.
- ▶ **Warning:** The Nox T3s recorder and its accessories should be removed from the patient before use of the USB connector to prevent electric shock. The USB connector shall only be used for the purposes of configuring the device and downloading data from the device.
- ▶ **Warning:** There are no user serviceable parts inside the Nox T3s recorder. The device should be serviced by authorized parties only. Service performed by non-authorized parties may affect data analysis and result in possible incorrect treatment. The warranty is void if the Nox T3s recorder is opened (except for opening of the battery compartment).
- ▶ **Warning:** No modification of the Nox T3s recorder and its accessories is allowed. Un-authorized modifications could result in the device not performing as intended and cause serious harm to the patient. To ensure patient safety and effective use of the Nox T3s System, only use accessories that have been validated for use by Nox Medical. Refer to section "Compatible Sensors and Devices".
- ▶ **Warning:** Remove batteries from the Nox T3s recorder if it is not used within 30 days to prevent damage from possible battery leakage and prevent possible minor burns to the operator/patient.
- ▶ **Warning:** Do not autoclave or immerse the Nox T3s recorder and accessories in any kind of liquids. Ingress of liquids may result in electric shock.

- ▶ **Warning:** Only use United States Environmental Protection Agency (EPA) registered products for cleaning of the Nox T3s recorder and accessories to prevent harm to the operator/patient.
- ▶ **Warning:** The Nox T3s recorder is NOT suitable for use in presence of a flammable anesthetic mixture with air or with oxygen or nitrous oxide. That could lead to the creation of electrostatic charges or temperature exceeding limits resulting in sparks or ignition, causing burns or explosions.
- ▶ **Warning:** As with all medical equipment, carefully route cables and connections to reduce the possibility of entanglement or strangulation.
- ▶ **Caution:** The Nox RIP belts should fit the patient snugly without being uncomfortably tight to avoid discomfort.
- ▶ **Warning:** The Nox disposable RIP belts, Nox nasal cannulas, Nox filter tube connectors, mask pressure tubes and Nonin Wristband are single patient use. Using the same Nox disposable RIP belts, cannula, filter tube connector, mask tubing and wristband on more than one patient poses a risk of cross-infection.
- ▶ **Warning:** The disposable RIP belts are single use. Reusing the belts may affect the quality of recorded signals and lead to possible incorrect treatment.
- ▶ **Warning:** Electrodes should only be used by or in consultation with a healthcare provider familiar with their proper placement and use. Not using and placing the electrodes correctly may affect recording of data, and therefore interpretation and diagnostics.
- ▶ **Warning:** The electrodes should be applied only to intact, clean skin (e.g. not over open wounds, lesions, infected or inflamed areas) to prevent infections.
- ▶ **Warning:** To prevent cross-contamination, make sure the Soft SpO2 sensor is properly cleaned after turning on the Nonin 3150 BLE pulse oximeter by inserting a finger (other than the patient's) in the sensor. Refer to 3rd party instructions for use accompanying the pulse oximeter for cleaning instructions.
- ▶ **Caution:** The Nox T3s recorder and its accessories should always be transported in its accompanying carrying case to ensure adequate protection and prevent damage.



- ▶ Please read this manual carefully before use, especially sections marked with an exclamation mark.

Instructions for Operators

Operators should contact Nox Medical or its sales representatives

- for assistance, if needed, in setting up, attaching, operating or maintaining the Nox T3s system, its accessories, and as applicable external sensors and auxiliary devices that have been validated with the system; or
- to report unexpected operation or events.

Support information and information about Nox Medical's sales representatives can be found on Nox Medical's website: www.noxmedical.com/distributors.

Nox T3s Description

The Nox T3s is a body worn ambulatory sleep recorder.

The input channels and built-in capabilities of the device include the following:

- 2 bipolar channels; for recording of electrocardiography (ECG), electromyography (EMG), electroencephalography (EEG) or electrooculography (EOG)
- 1 ground channel
- 1 pressure/cannula channel; for recording of nasal or mask pressure
- 2 respiratory effort channels; for recording of abdomen and thorax ventilatory effort signals
- 3-D built-in acceleration sensor; for recording of patient’s position and activity
- Built-in microphone; for recording of audio and snoring
- Built-in Bluetooth® module; to support wireless connectivity allowing the device to record signals from compatible auxiliary devices
- Built-in light sensor; for recording of ambient light

The Nox T3s recorder is powered with one AA battery.

Nox T3s Interface

The Nox T3s recorder interface consists of a display, buttons, sensor inputs/connections and a USB connector. The USB connector is placed under the battery lid and connects to a USB Type-C cable for device configuration and data download. See the figures and tables below for detailed description.

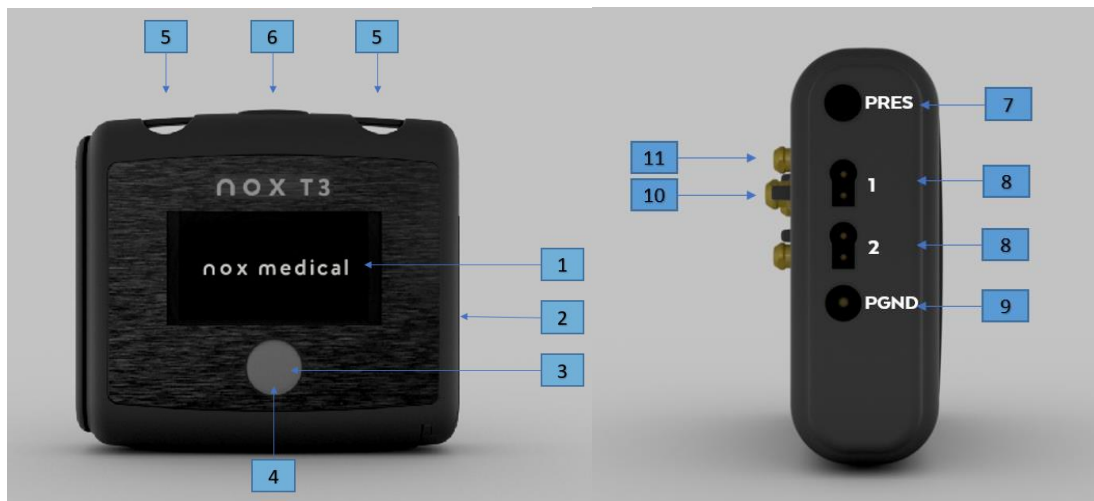

NUMBER	FUNCTION
1	Display
2	Battery lid – Covers the battery and the USB connector
3	Push button
4	Indicator light for device status Light sensor located under the shaded transparent button

- 5 2 Clip strap loops
- 6 Microphone – For recording of respiratory sounds
- 7 Pressure lock (labeled with “PRES”) – Connects to external nasal cannula/mask pressure tube
- 8 Channel 1 & 2 (labeled with “1” and “2”) – Bipolar touch proof inputs
- 9 Reference ground input for channels 1 and 2 (labeled with “PGND”) – Unipolar touch proof inputs
- 10 2 Metal snaps – Connect to abdomen cable
- 11 2 Metal snaps – Connect to thorax RIP belt

Operating Nox T3s

The Nox T3s recorder is operated with one push button located on the front panel. Pressing the button turns on the display. The display will automatically turn off in 20 seconds.

The version of the Nox T3s Recorder can be seen on the label on the back of the recorder.

The firmware version on the recorder can be seen on the startup screen or in the Noxturnal software when connected over USB.

Connecting Nox T3s to a Computer

To connect Nox T3s recorder to a computer you need to access the USB connector on the device. The USB connector is placed under the battery lid making it inaccessible and tamper proof for children. To open the battery lid, press with the Nox battery Lid Key, accompanying the Nox T3s system kit, on the battery lid pin and slide the battery lid down, towards the bottom of the device. The Nox T3s connects to the computer by using USB Type-C cable. The battery does not have to be inserted while the device is connected to the computer.

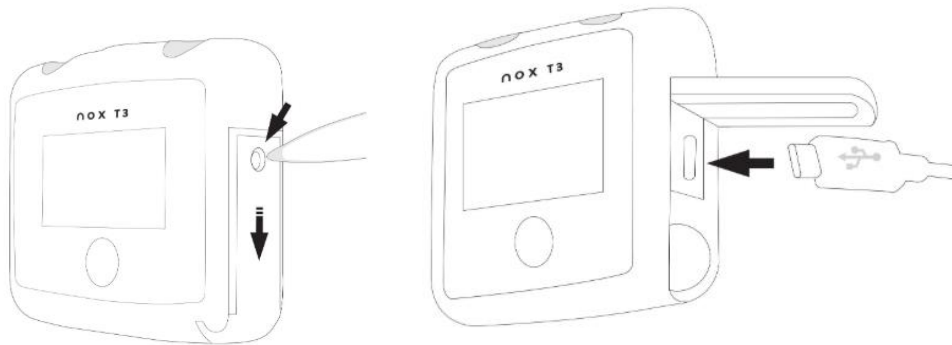

When the Nox T3s recorder is connected to the computer the device display lights up with a message indicating the device is connected to the computer.

For IT environments that restrict USB port access to USB peripherals, the following vendor id (VID) and product id (PID) shall be allowed on the network for communicating with Nox recorder devices: VID=0x1E0A, PID=0x1002.

Configuring and Downloading from Nox T3s

To download a recording or configure a Nox T3s recorder you will need to start the Noxturnal US software application (version 6.0 or higher) and connect the device to the computer. Please refer to the Noxturnal US manual for more information on how to perform those tasks.

When you are done working with the device eject the device from the Noxturnal US software and unplug the USB Type-C cable. Insert the battery and close the battery compartment by pressing the lid back towards the device without causing any strain, then slide it back into position, towards the top of the device.

Starting/Stopping by Connecting RIP belts on Nox T3s

If the Nox T3s recorder has been configured to start the recording by connecting Nox disposable RIP belts, the recording will start when the Nox Thorax RIP belt is connected. The device will instruct you to "Connect belts to record". When the Nox Thorax RIP belt has been connected the "Recording

Duration” is displayed and the REC symbol appears at the top of the screen. After the display turns off, the light under the button will blink green intermittently indicating that a recording is taking place. If the Nox Thorax RIP belt is disconnected for more than 30 seconds, the recording will stop.



Starting/Stopping by Pressing Button on Nox T3s (manual)

If the Nox T3s recorder has been configured to start the recording manually by pressing button, you can use the button to manually start a recording. Pressing the button turns on the display. The device will instruct you to “Hold button down to start recording”. Please do so until you see “Recording Duration” displayed. Note the button needs to be pressed down for approximately 4-5 seconds before “Recording Duration” displays. At this point the device has started to record data and the REC symbol appears at the top of the screen. After the display turns off, the light under the button will blink green intermittently indicating that a recording is taking place. Use the same method to manually stop the recording.



If the duration of the recording has been specified during configuration, the recording will automatically stop after the specified duration.

Starting Nox T3s at a Scheduled Time

If the Nox T3s recorder has been configured to automatically start a recording at a scheduled time, there are no actions required for the recording to start. Pressing the button before the recording has started will display a countdown to the specified start time of the recording. If the recording has begun,

the display shows the current duration of the recording and the REC symbol appears on the top of the screen.



Nox T3s Status

Indicator Light

The indicator light on the Nox T3s recorder blinks green when a recording is in progress and the device is functioning normally. When there are any device warnings the indicator light blinks amber. Warnings might include:

- Battery low
- Device not licensed.

Displays

Information about the recording duration, recording status and device connections is shown on the display. If the display is turned off, pressing the button turns it on. By pressing the button again, you will loop through the available displays. The display will turn itself off again after being inactive for 20 seconds.

The display includes information about device connection, time and battery status.

1. A Bluetooth symbol and an “X” or a checkmark “✓” are visible on all displays. This symbol shows the status of the Bluetooth connection with the oximeter. An “X” means there is not Bluetooth connection, a “✓” means there is a Bluetooth connection.
2. The device’s clock. When Nox T3s is configured, the clock is synchronized with the PC and is shown at the top of the display.
3. On the top right corner is a battery indicator which shows the battery status. The battery indicator is full when the device has fresh batteries.



The first display that shows up after the device is turned on shows information about the recording planned or ongoing as explained in previous sections. The second display shows the status of the oximeter connection.

1. An “X” next to SpO₂ indicates that the oximeter is not connected to the device. Once an oximeter has been connected, a checkmark “✓” will appear.
2. The Bluetooth device address (BDA) of the oximeter that the device is trying to connect to or is connected to.



The third display is the Study Quality display and shows the successful study indicators. The successful study indicator helps determine if the recording includes the necessary signals for respiratory analysis. In the case of an unsuccessful study indication, the patient can do additional recordings without the need to return or re-configuring the device.

Each square represents a single recording, the number of squares is equal to the number of recordings. An empty square represents a recording yet to be performed. A filled square with either a checkmark or a cross represents that recording successful study indicator. The successful study indicator is marked when the recording is stopped. For the evaluation of the successful study indicator, the minimum recording length is 15 minutes.

If one or more of the scheduled recordings is failed, an extra scheduled recording is added automatically.

1. Filled square with a checkmark "✓" indicates a successful study.
2. Filled square with an "X" indicates a failed study.
3. An empty square represents a recording yet to be performed.

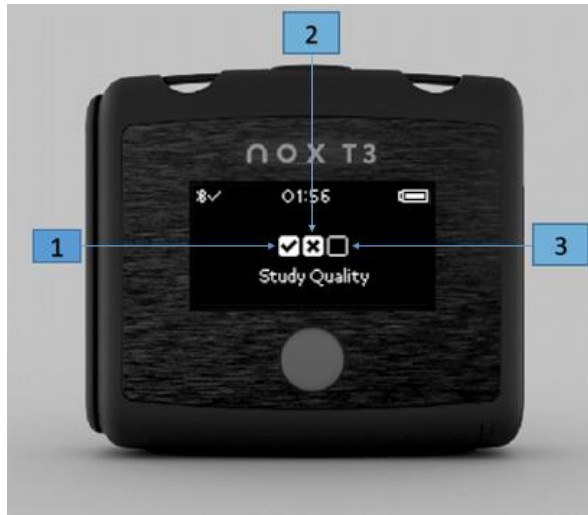

The evaluation of the successful study indicator is based on respiratory signals (Nasal Cannula, Abdominal and Thorax RIP) and SpO2 signal. If 2 out of 3 Respiratory signals and the SpO2 signal meet the predetermined quality thresholds for the specified duration threshold (4 hours or 6 hours) set in the recordings configuration, with 4 hours being the default setting, the recording successful study indicator is marked with a checkmark.

Other displays:

When the Nox T3s recorder is connected to a computer by using USB-C cable an image showing this is displayed.



Nox T3s Patient Hookup

In most cases the hookup takes place at the patient's home and the patient hooks up the device by using the Nox T3s recorder hookup instructions. It is then recommended that a healthcare professional with relevant qualifications and skills demonstrates the steps needed to be conducted at the patient's home to the patient, or to caretakers in the case of pediatric patients. Hookup instructions are available on the Nox Medical Support Site for self-application by the patient.

The following points should be demonstrated to the patient or caretakers of pediatric patients:

1. Attaching Nox T3s recorder and sensors.
2. Testing of sensors connections.
3. Starting and stopping a recording (if manual recording mode is being used)
4. Status indications on the display.

It is important to remind the patient/caretaker to follow the instructions given, prior to the recording.

Before sending the patient home:

1. Make sure the Nox T3s recorder has been prepared correctly.
2. Make sure the carry case contains all the equipment needed to perform the recording in the patient's home, including batteries.



- ▶ Note: Children should under no circumstances hook up the Nox T3s by themselves.
- ▶ Warning: Do not use damaged equipment, sensors or accessories. This may result in bad performance of the Nox T3s System or patient/operator injury.
- ▶ Warning: As with all medical equipment, carefully route cables and connections to reduce the possibility of entanglement or strangulation.
- ▶ Caution: The Nox T3s recorder and its accessories should always be transported in its accompanying carrying case to ensure adequate protection and prevent damage.

Inserting a Battery to the Nox T3s

The list below is provided to assist the user in selecting the appropriate battery type for a Nox T3s study:

- Alkaline batteries can be used to record from 8 to 16 hours depending on battery type.
- Lithium batteries can be used to record from 20 to 33 hours depending on study type and battery.
- Lithium batteries are optimal for multiple night recordings because it is possible to record 3 nights or more without having to change the batteries.
- Rechargeable NiMH batteries can be used to record for 1 hour to 1.5 hours per 200 mAh capacity. Thus, a standard 2000 mAh battery can record from 10 to 15 hours.



- ▶ Note: Always use fully charged or fresh **lithium batteries** for each recording to prevent the need for the sleep study to be repeated.
- ▶ Note: All lithium batteries used with the Nox T3s recorder shall be per the standard IEC 60086-4 Primary batteries – Part 4: Safety of lithium batteries.
- ▶ Note: The recording durations listed above depend on the quality of the batteries used.

- ▶ Note: Further information on multiple night recordings can be found on the Nox Medical Support Site.

Before you start a recording, you should make sure that the Nox T3s recorder has a new or fully charged battery. To insert a new battery, do the following:

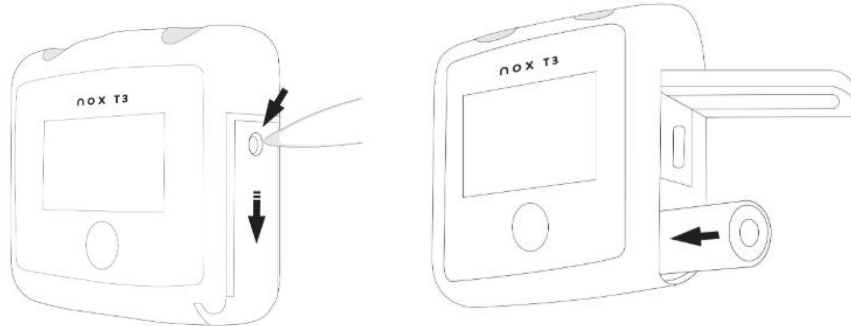

1. Open the battery compartment by pressing down the battery lid pin with the Nox Battery Lid Key accompanying the Nox T3s system kit and slide the lid towards the bottom of the device.
2. Place one AA battery in the compartment aligning the battery poles as illustrated on the back of the device (the positive (+) pole is towards the battery lid).
3. Close the battery compartment by pressing the lid back towards the device without causing any strain, then slide it back into position, towards the top of the device. Make sure the lid is securely closed.

The status of the battery can be checked by turning on the device. The battery status indicator positioned in the upper right-hand corner of the device display allows you to check the battery status. When the battery is running low during a recording the device will automatically stop the recording.

Attaching the Nox T3s and the Nox RIP Belts



- ▶ Caution: The Nox T3s recorder and Nox disposable RIP belts should be worn over clothing to prevent allergic reaction to the equipment materials.
- ▶ Warning: The Nox disposable RIP belts are single use and single patient use. Re-using the Nox disposable RIP belts may affect the quality of recorded signals and lead to possible incorrect treatment. Using the same Nox disposable RIP belt on more than one patient poses a risk of cross-infection.

Step 1

Snap the clips that are attached to the Nox T3s recorder to the patient's shirt.

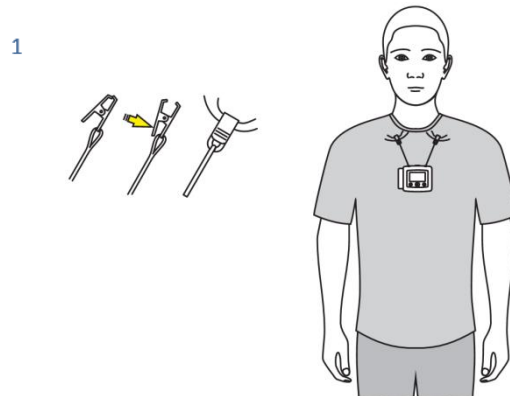

Step 2 to Step 4

- Snap the Nox Abdomen Cable to the back of the device.
- Place a Nox disposable RIP belt around the thorax and snap its ends to the back panel of the device.
- Adjust the Nox Abdomen Cable length as needed by wrapping it around the abdomen connection unit. Place a Nox disposable RIP belt around the abdomen and snap it in place.

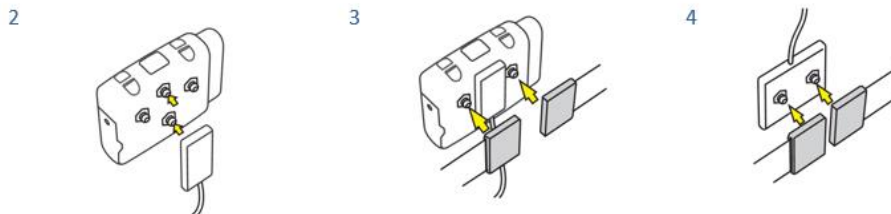

Step 5

Attaching the Nox T3s recorder and Nox disposable RIP belts is now completed.

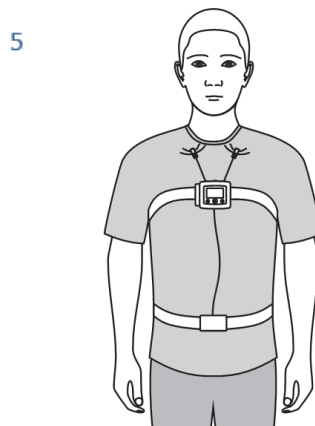

Adjusting the Nox RIP Belts



- ▶ **Caution:** The Nox disposable RIP belts should fit the patient snugly without being uncomfortably tight to avoid discomfort.
- ▶ **Note:** For most patients, the Nox disposable RIP belts do not need to be adjusted if the correct belt size is chosen based on the patient's abdomen circumference and/or body mass index (BMI). Belt size selection tables accompany Nox disposable RIP belts packages for more detailed instruction.

Fit the Nox disposable RIP belts around the patient's waist and thorax and adjust the length using the loop on each end to adjust the belt length such that the belt covers about two thirds of the patient's circumference when the belt is unstretched. The length is fixed with hooks on the plastic connector of the belt.

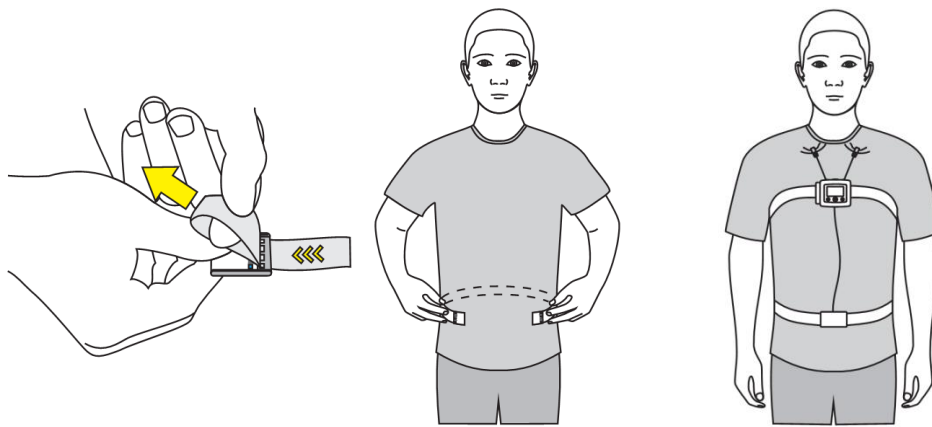

Attaching the Nox Nasal Cannula



- ▶ **Warning:** The Nox nasal cannulas are single patient use. Using the same nasal cannula on more than one patient poses a risk of cross-infection.
- ▶ **Note:** Medical tape can be used to hold the cannula against the cheeks to secure the cannula in place if necessary.
- ▶ **Note:** The Nox nasal cannula with filter has a built-in hydrophobic filter and is the preferred way to measure nasal airflow and snoring as it is designed to maximize the signal quality and fits directly with the Nox T3s recorder. If you use a non-filtered Luer-lock cannula, it is necessary to use a filter tube connector from Nox Medical to interface with the Nox T3s recorder.

Step 1 Place the nasal prongs gently in the nostrils. The prongs should point downwards inside the nostrils.

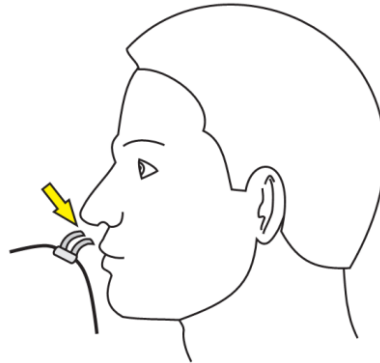

Step 2 Pull the cannula tubing over the ears and then position it under the chin.

Step 3 Slide the fastener snugly under the chin to hold the cannula tubing securely in place.

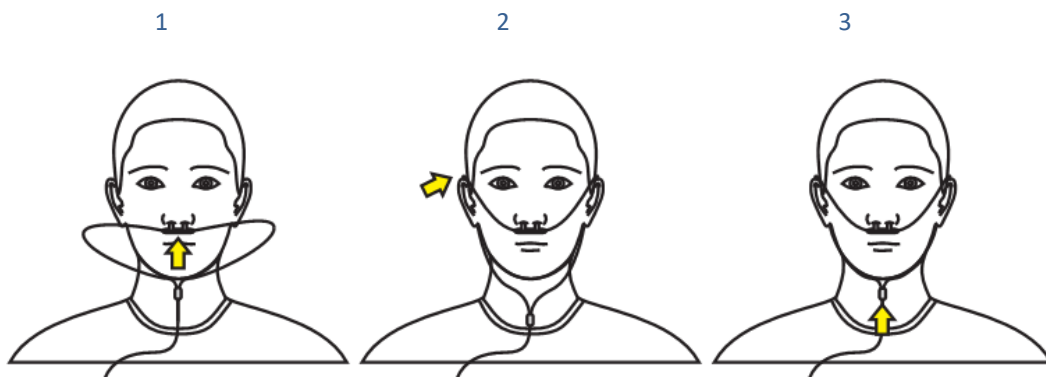

Refer to the section “Compatible Sensors and Devices” regarding the types of Nox nasal cannulas that have been validated with the Nox T3s device.

Measuring Mask Pressure



- ▶ **Warning:** Mask pressure tubes and Nox filter tube connectors are single patient use. Using the same mask pressure tube and filter tube connector on more than one patient poses a risk of cross-infection.
- ▶ **Note:** The mask pressure tube can only be connected to the pressure lock on the Nox T3s recorder by using the Nox filter tube connector.

A mask pressure tube is used for connection to positive airway pressure (PAP) masks for measuring mask pressure. The pressure tube connects to the pressure lock on the Nox T3s recorder via a filter tube connector from Nox Medical.

Refer to the section “Compatible Sensors and Devices” regarding the types of mask pressure tubes that have been validated with the Nox T3s system.

Measuring ExG Signals



- ▶ Warning: Electrodes should only be used by or in consultation with a healthcare provider familiar with their proper placement and use. Not using and placing the electrodes correctly may affect recording of data, and therefore interpretation and diagnostic
- ▶ Warning: The electrodes should be applied only to intact, clean skin (e.g. not over open wounds, lesions, infected or inflamed areas) to prevent infections.
- ▶ Warning: Make sure the conductive parts of electrodes and associated connectors, including the neutral electrode, do not contact other conductive parts including earth to prevent potential serious harm to the operator/patient.

The Nox T3s recorder can record any combination of two ExG channels, that is, EMG, EOG, EEG or ECG. The electrode leads connect to the bipolar touch-proof inputs on the Nox T3s recorder. The electrodes are placed on applicable locations on the body depending on the type of recording.

Refer to the section “Compatible Sensors and Devices” regarding the types of electrodes and leads that have been validated with the Nox T3s system.

Measuring Pulse and Oxygen Saturation using Nonin 3150 BLE Pulse Oximeter



- ▶ Warning: The Nox T3s system is **NOT certified to be used for continuous monitoring** where failure to operate can cause injuries or death of the patient.
- ▶ Warning: Avoid excessive pressure to the sensor application site as this may cause damage to the skin beneath the sensor.
- ▶ Warning: To prevent improper performance and/or patient injury, verify compatibility of the Nox T3s recorder, oximeter, sensor(s), and accessories before use.
- ▶ Warning: Before changing the batteries, make sure the oximeter is off and the sensor is not applied to a digit.
- ▶ Caution: The oximeter has motion tolerant software that minimizes the likelihood of motion artifact being misinterpreted as good pulse quality. In some circumstances, however, the device may still interpret motion as good pulse quality.
- ▶ Caution: To avoid the risk of confusing or misinterpreting patient data when transmitting data via Bluetooth, verify that the oximeter is paired with the correct Nox T3s recorder.
- ▶ Caution: Do not fasten the pulse oximeter too tightly around the patient’s wrist. Inaccurate readings and patient discomfort could result.
- ▶ Caution: Do not use a damaged sensor. If the sensor is damaged in any way, discontinue use immediately and replace the sensor.
- ▶ Caution: The oximeter is designed to determine the percentage of arterial oxygen saturation of functional hemoglobin. Factors that may degrade pulse oximeter performance or affect the accuracy of the measurement include the following:
 - excessive ambient light
 - excessive motion
 - electro-surgical interference

- blood flow restrictors (arterial catheter, blood pressure cuffs, infusion lines, etc.)
 - moisture in the sensor
 - improperly applied sensor
 - incorrect sensor type
 - poor pulse quality
 - venous pulsations
 - anemia or low hemoglobin concentrations
 - cardiogreen and other cardiovascular dyes
 - carboxyhemoglobin
 - methemoglobin
 - dysfunctional hemoglobin
 - artificial nails or fingernail polish
 - residue (e.g., dried blood, dirt, grease, oil) in the light path
- ▶ Caution: When using the oximeter in the home, avoid exposing it to lint and dust.
 - ▶ Caution: The pulse oximeter may not work when circulation is reduced. Warm or rub the finger or reposition the sensor.
 - ▶ Note: Refer to 3rd party instructions for use accompanying the pulse oximeter and/or oximeter sensor for maximum oximeter application time at a single site.
 - ▶ Note: Refer to 3rd party instructions for use accompanying the pulse oximeter and oximeter sensor for additional warnings and cautions.
 - ▶ Warning: The Nonin wrist band is single patient use only. The wrist band may be cleaned, refer to 3rd party instructions for use accompanying the pulse oximeter for cleaning instructions, but after cleaning the wrist band should only be applied to the same patient, not to a different patient.
 - ▶ Batteries may leak or explode if used or disposed of improperly. Remove batteries if the device will be stored for more than 30 days. Do not use different types of batteries at the same time. Do not mix fully charged and partially charged batteries at the same time. These actions may cause the batteries to leak.

The Nox T3s recorder can communicate with an auxiliary Bluetooth® pulse oximeter for recording oxygen saturation levels (SpO₂), pulse rate, and plethysmography data.

Refer to the section “Compatible Sensors and Devices” regarding the types of pulse oximeters and sensors that are supported by the Nox T3s system.

Inserting Batteries into the Nonin 3150 BLE Pulse Oximeter

Refer to the 3rd party accompanying instructions regarding replacement of batteries when using the Nonin 3150 BLE pulse oximeter.



- ▶ Note: Single use batteries last up to 48 hours of use so it is important to track the number of measurements made with the oximeter. It is recommended to change the batteries after 2-3 recordings depending on the quality of the batteries being used.

- Note: If you are using rechargeable batteries, it is recommended that you replace them before every recording.

Selecting Oximeter Sensor Size

Nonin Reusable Soft Pulse Oximeter Sensor

Soft sensor size recommendations are based on finger height (thickness). The finger height (H) is measured as shown in the figure below.

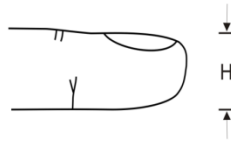

For finger height from 7.5 mm (0.3 in) to 12.5 mm (0.5 in), size small should be selected.

For finger height from 10.5 mm (0.4 in) to 19.0 mm (0.7 in), size medium should be selected.

For finger height from 12.5 mm (0.5 in) to 25.5 mm (1.0 in), size large should be selected.

Attaching the Nonin 3150 BLE Pulse Oximeter and Soft Sensor

The Nonin 3150 BLE WristOx₂ oximeter package accompanying the Nox T3s system kits includes:

- WristOx₂® Model 3150 BLE pulse oximeter
- Model 8000SM-WO₂, reusable soft sensor
- 1 wrist band
- CD-ROM of the operator's manual

Step 1 to Step 4

1. Separate the short end of the wristband from the long end.
2. Insert the short end in the loops on the oximeter.
3. Place the probe wire between the short and long end of the wristband. Attach the long end to the short end to secure the wristband on the oximeter and the probe wire between the two ends.
4. The oximeter is now securely placed on the wristband and the probe wiring is secured between the two ends, forming a loop that prevents direct pulling of the connector.

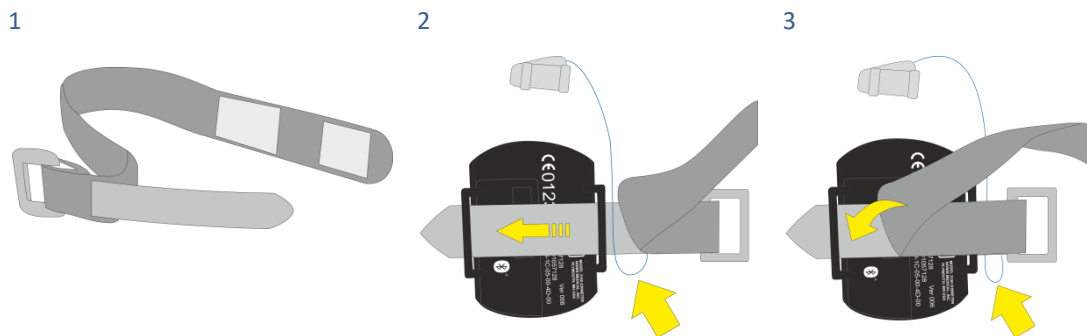

4

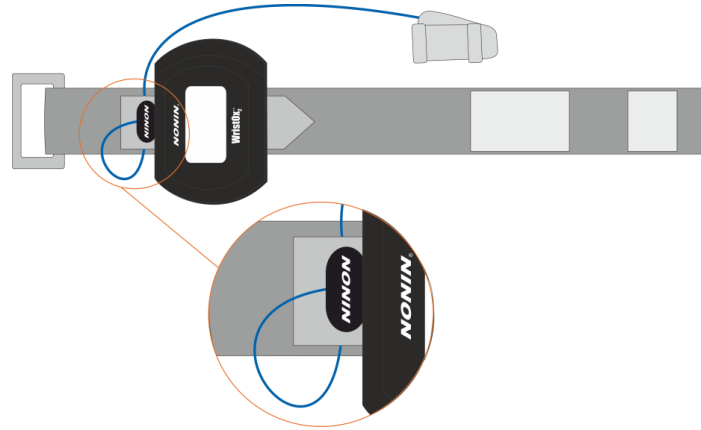

Step 5 to Step 6



► Note: To prevent the oximeter sensor from falling off, secure its cable with medical tape.

- 5. Place the wristband around the patient's wrist.
- 6. Put the probe on a finger.

5

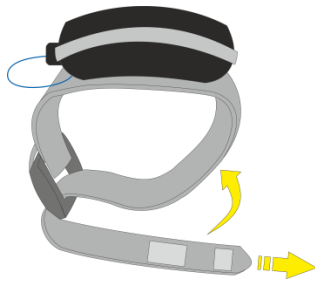

6

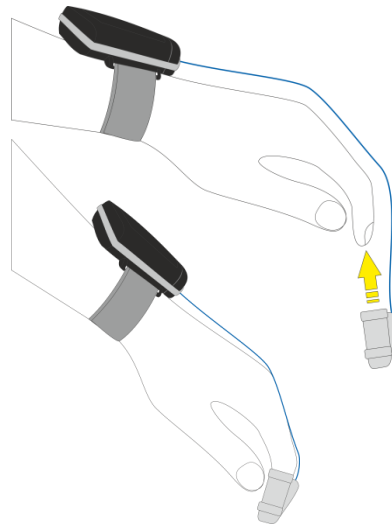

Establishing a Connection between the Nonin 3150 BLE Pulse Oximeter and Nox T3s

Before you can send out the Nox T3s recorder and accessories for an ambulatory recording, you need to make sure that a connection has been established between the Nox T3s recorder and the oximeter. The pairing of the Nox T3s recorder and the oximeter is done during the configuration of the device in the Noxturnal US software. Follow the instructions below in order to establish a successful connection between the Nox T3s recorder and the Nonin 3150 BLE oximeter.



Note: The Nox T3s recorder will only connect to Nonin 3150 BLE oximeters and does not support connecting to the Nonin 3150 Classic oximeters. Refer to the Nox Medical support page for further information.

Pairing Process

Step 1. Inserting Batteries

Start by inserting fresh/fully charged batteries in the Nonin 3150 BLE pulse oximeter.

Step 2. Turning on the Nonin 3150 BLE Pulse Oximeter

Turn on the Nonin 3150 BLE pulse oximeter by pressing the gray activation button (red circle on the picture below) on top of the device and you will see the display turn on.



Step 3. Connect the Nox T3s recorder with a USB cable and follow the configuration in Noxturnal US

Fill in the BDA number of the pulse oximeter found on the back of the Nonin 3150 BLE oximeter.

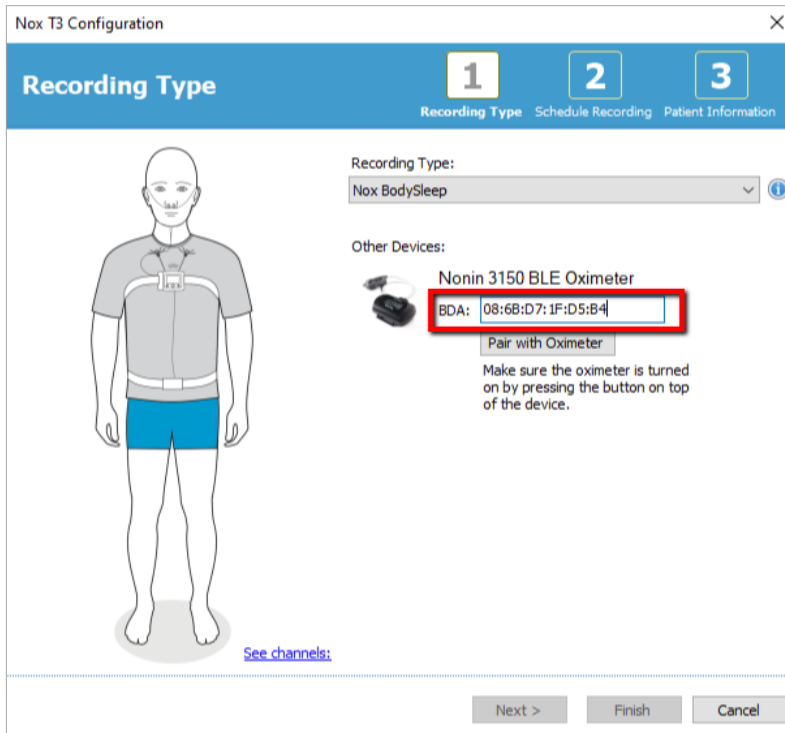

Click Pair with Oximeter and the pairing will be performed either result in a successful pairing.

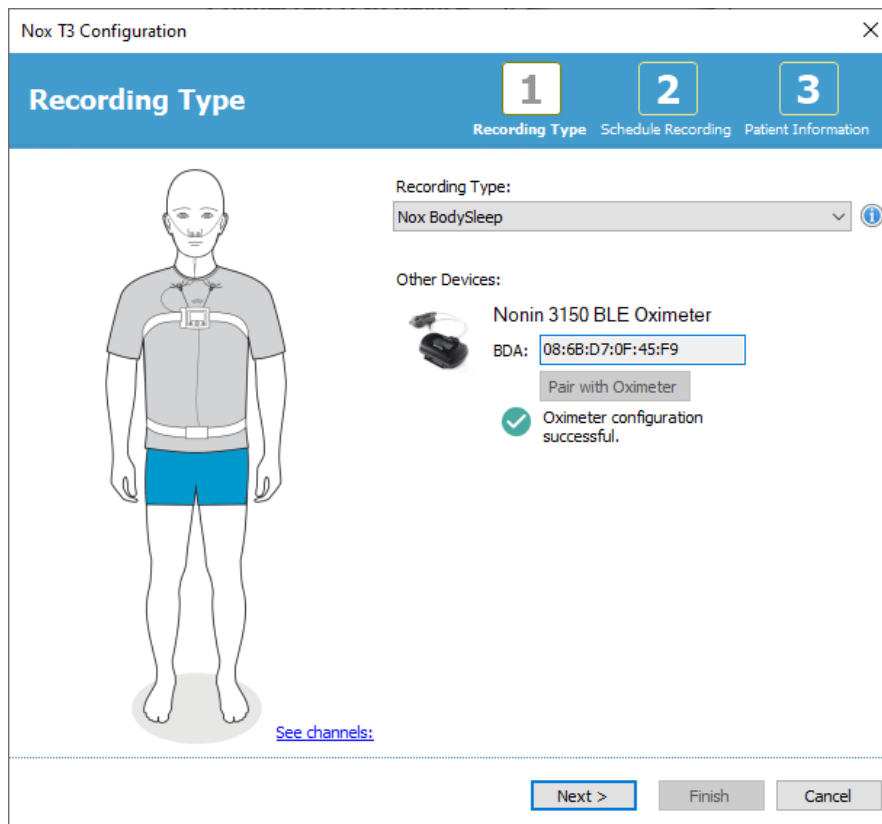

Or an unsuccessful pairing.

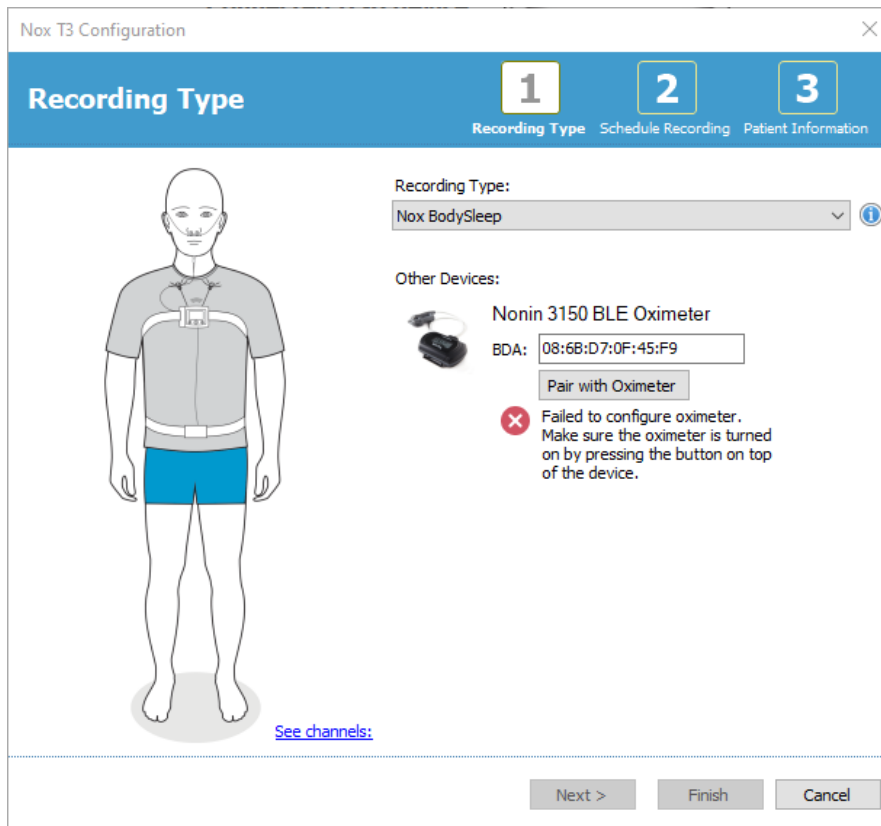

If not successful follow the troubleshooting tip in the software or see the troubleshooting tips below.

Step 4. Bluetooth Wake up mode.

If the pairing was successful during the configuration step in Noxturnal US software the Nonin 3150 BLE has been put into Bluetooth Wake up Mode. That is indicated by the Bluetooth symbol blinking on regular time interval of the study.



The Nonin 3150 BLE will then turn on when the Nox T3s recorder starts a study (either manual start or scheduled start).

Now the Nox T3s is ready to be packed and handed over/shipped to customer.

Troubleshooting Tips

Troubleshooting during oximeter pairing in Noxturnal US

Incorrect BDA number:

If failing, check the BDA number of the device and make sure it matches the number on the Nonin 3150 BLE oximeter.



Correct BDA number but devices not pairing

- a) Restart the oximeter by removing the batteries and inserting batteries again to the oximeter. Then hold the grey activation button to turn on the device. Resume the pairing process from Step 3 above.
- b) Restart the Nox T3s by unplugging the Nox T3s from the computer and plugging it back in again. Resume the pairing process from Step 3 above.



Note: This pairing only works for Nonin 3150 BLE oximeters and is not supported with Nonin 3150 Classic oximeters. Refer to the Nox Medical support page for further information.

Note: If this happens repeatedly, it might be necessary to send the oximeter in for service.

Troubleshooting of oximeter connection during hook-up (after successful pairing in Noxturnal US)

Verify that the BDA number of the oximeter used matches the number used to configure the Nox T3s Recorder. The BDA number used in configuration of the Nox T3s can be found on in the display of the device that shows the status of the oximeter connection. The oximeter BDA number is displayed on the back of the oximeter.



In the case of the number on the device does not match the number of the oximeter it is necessary to re-configure the Nox T3s in Noxturnal US software and insert there the correct BDA number as in step 3 of the pairing:

Correct BDA number but oximeter still marked with “x” on status display:



This means that the Nox T3s recorder and the oximeter are not pairing as expected. To resolve try the following:

- c) Restart the oximeter by removing the batteries and inserting batteries again to the oximeter. Then hold the grey activation button to turn on the oximeter.
- d) Reboot the Nox T3s recorder by simply waiting for the Nox T3s to turn off (it turns off automatically in 2 minutes after it has been turned on) and then, turn on the Nox T3s again by pushing the button or removing and re-inserting the battery.



Note: If this does not solve the issue and this happens repeatedly, it might be necessary to send either Nox T3s or the oximeter in for service.

For further information on troubleshooting refer to the Nox Medical Support Site.

Maintenance

The Nox T3s System is only intended to be maintained by professionals (healthcare professionals and service personnel) with relevant qualifications and skills.

The Nox T3s recorder and accessories should be stored in a clean, dry place.

Handle the Nox T3s recorder with care and protect it against mechanical shocks, dirt, and liquids. The device is not waterproof or splash proof.

To update the Nox T3s recorder you will need the applicable Noxturnal US software (version 6.0 or higher) running on the computer which the device is connected to. Please refer to the Noxturnal US manual for more information on how to perform this task.

No regular testing of the Nox T3s recorder or accessories, including patient cables, is needed.

The service life of the Nox T3s recorder and Nox T3s carry case is 5 years or the equivalent of 1000 studies in total, given that 200 studies are performed in a year.

The service life of the Nox Abdomen Cable is 1 year.

The service life of the Nox Snap-on Electrode Leads and Nox Bipolar Snap-on Electrode Leads is 1 year.

The service life is dependent on full compliance with the direction for use given in this manual.



- ▶ **Warning:** Remove batteries from the Nox T3s recorder if the device is not used within 30 days to prevent damage from possible battery leakage and prevent possible minor burns to the operator/patient.
- ▶ **Warning:** There are no user serviceable parts inside the Nox T3s recorder. The device should be serviced by authorized parties only. Service performed by non-authorized parties may affect data analysis and result in possible incorrect treatment. The warranty is void if the Nox T3s recorder is opened (except for opening of the battery compartment).
- ▶ **Warning:** No modification of the Nox T3s recorder and its accessories is allowed. Un-authorized modifications could result in the device not performing as intended and cause serious harm to the patient.
- ▶ **Note:** It is never recommended to downgrade the firmware of the Nox T3s recorder. Downgrading the firmware will result in losing the calibration for the device: calibration values will be replaced with default values that might affect the pressure and impedance signals being recorded. Only upgrade the firmware of the Nox T3s recorder with firmware files that come directly from Nox Medical.

Environmental Conditions

Temperature	Operation: +5°C to +40°C (+41°F to +104°F)
	Transport/Storage: -25°C to +70°C (-13°F to +158°F)
Relative Humidity	Operation: 15-90% (non-condensing)
	Transport/Storage: 10-95% (non-condensing)

Pressure

Withstands atmospheric pressures from 700 hPa to 1060 hPa

Calibration

The Nox T3s recorder is factory calibrated. No further calibration is needed.

Cleaning of Nox T3s and its Accessories



- ▶ Warning: Do not autoclave or immerse the Nox T3s recorder and accessories in any kind of liquids. Ingress of liquids may result in electric shock.
- ▶ Warning: Only use United States Environmental Protection Agency (EPA) registered products for disinfection of the T3s System to prevent harm to the operator/patient.
- ▶ Note: Clean the Nox T3s recorder separately from its associated sensors.
- ▶ Note: The Nox T3s recorder components are NOT intended to be sterilized.
- ▶ Note: Reusing single-use products on more than one patient poses a risk of cross-infection.
- ▶ Note: Regarding cleaning/disinfection and re-use of 3rd party components and 3rd party sensors refer to the applicable 3rd party accompanying instructions.
- ▶ Note: Incorrect cleaning of the Nox T3s System's reusable components can result in contamination and/or biologic risk to patient or clinician.
- ▶ Note: Soiled towelettes/cloths should be disposed of as biohazard material in accordance with federal, state, and local regulations.

All reusable components should be cleaned immediately after use to prevent accumulation of residual soil and minimize soil transfer between patients.

Nox T3s System Cleaning instructions

MATERIALS/EQUIPMENT:

- Endozime® AW Plus
- Lint-free cloths
- Gloves
- Soft bristle nylon brush (i.e. electrode brush, toothbrush, or nail brush)
- PDI Sani-Cloth Plus Germicidal Disposable Cloth or equivalent validated disinfectant*

CLEANING/DISINFECTING PROCEDURE:

1. Prepare a solution with the Endozime® AW Plus hospital grade cleaner
 - Follow the instructions accompanying the hospital grade cleaner
2. Dampen a lint-free cloth with the solution
 - Do not pour or spray any liquids on the Nox T3s Recorder
 - Do not allow any liquids to enter any openings on the Nox T3s Recorder
 - Do not immerse the cables in liquid
 - Avoid contact of the cleaning solution to cable/electrode connectors
3. Wipe all surface areas thoroughly to remove all visible soil and contaminants. Wipe the component for at least 2 minutes. Use a soft bristle nylon brush if necessary.

4. Visually inspect the cleaned components to ensure no soil remains. Pay good attention to all junctions and details. Repeat steps 2 and 3 if necessary.
5. Allow components to air dry completely before disinfection (minimum of 3 minutes)
6. For disinfection, take a new wipe of PDI Sani-Cloth Plus Germicidal Disposable Cloth or equivalent validated disinfectant*
7. Wipe all surface areas of the component with the disinfectant for at least three minutes
 - If other disinfection materials are used than PDI Sani-Cloth Plus Germicidal Disposable Cloth make sure:
 - they are safe to use on metals and plastics
 - to read the instructions from the manufacturer regarding required contact time of the solution to provide sufficient disinfection
8. Allow components to air dry completely before next use (minimum 1 minute)
9. Visually inspect the components under adequate lighting conditions (and magnification if needed) to confirm that the cleaning/disinfection process has not damaged components. Inspect for surface wear, discoloration, corrosion, or cracking. **

If necessary, the clips on the Nox T3s recorder can be removed before cleaning. The cleaning process described above also applies for the clips. If the clips are visibly contaminated, they should be replaced.

* PDI Sani-Cloth Plus Germicidal Disposable Cloth are Environmental Protection Agency (EPA) registered product for disinfection of medical devices in the United States of America.

** If any component damage occurs during cleaning process, contact Nox Medical immediately at support@noxmedical.com. Do not attempt to use the Nox T3s System until the device has been inspected and repaired by authorized Nox Medical personnel.

The Nox disposable RIP belts are single patient use ONLY.

The Nox nasal cannulas and filter tube connectors are single patient use ONLY.

Disposal

Follow local governing ordinances and recycling instructions regarding disposal or recycling of this device and accessories, including batteries.

Compatible Sensors and Devices



- ▶ **Warning:** No modification of the Nox T3s recorder and its accessories is allowed. Un-authorized modifications could result in the device not performing as intended and cause serious harm to the patient.
- ▶ **Note:** To ensure patient safety and effective use of the Nox T3s system, only use accessories that have been validated for use by Nox Medical.

The following table includes information on accessories, sensors and devices that have been validated with the Nox T3s recorder.

The items listed below are Nox products and have been validated for use with the Nox T3s recorder:

NOX DISPOSABLE RIP BELTS

Type	Catalogue Number
Nox RIP Belts Disposable, Extra Large 14 sets	551050
Nox RIP Belts Disposable, Large 20 sets	551040
Nox RIP Belts Disposable, Medium 20 sets	551030
Nox RIP Belts Disposable, Small 20 sets	551020
Nox RIP Belts Disposable, Pediatric 20 sets	551010

NOX NASAL CANNULAS/FILTER TUBE CONNECTORS

Type	Catalogue Number
Nox Cannula with filter, 40 units	552010
Nox Filter Tube Connector, 50 units	552110
Cannula with Luer-lock, Pediatric, 25 units	552151

NOX T3S SYSTEM COMPONENTS

Type	Catalogue Number
Nox Abdomen Cable, s	561212
Nox T3s Carry Case	568012
Nox Service Kit, s	569015
Nox Battery Lid, s	569020, 569022
Nox Clip Strap, s	569021
Nox Battery Lid Key	569014
Noxturnal US	NA
Noxturnal US CD	539012

NOX BIPOLAR SNAP-ON ELECTRODE LEADS

Type	Catalogue Number
Nox Snap On Double-Lead 50/100 cm, orange, keyhole connector, 1 unit	554310
Nox Snap On Double-Lead 30/50 cm, beige-orange, keyhole connector, 1 unit	554311
Nox Snap On Double-Lead 148/150 cm, grey, keyhole connector, 1 unit	554312
Nox Snap On Double-Lead 98/100 cm, beige-grey, keyhole connector, 1 unit	554313
Nox Snap On Double-Lead 148/150 cm, black, keyhole connector, 1 unit	554314
Nox Snap On Double-Lead 98/100 cm, beige-black, keyhole connector, 1 unit	554315
Nox Snap On Double-Lead 50/52 cm, white, keyhole connector, 1 unit	554316
Nox Snap On Double-Lead 30/32 cm, beige-white, keyhole connector, 1 unit	554317

NOX SNAP-ON ELECTRODE LEADS

Type	Catalogue Number
Nox Snap On Lead 100 cm (40 in), Green, 1 unit	554022
Nox Snap On Lead 50 cm (20 in), Beige-Green, 1 unit	554023

The items listed below are 3rd party products and have been validated for use with the Nox T3s recorder:

LEADS AND ELECTRODES

Type	Catalogue Number
Ambu Blue Sensor® Snap on Electrode, 50 units	554210
Ambu Snap on Electrode Disposable, small 25 units	554209

PULSE OXIMETERS

Type	Catalogue Number
Nonin WristOx ₂ Pulse Oximeter, Model 3150 BLE	541012

PULSE OXIMETER ACCESSORIES

Type	Catalogue Number
NONIN WristOx ₂ Soft Sensor – Small	553010
NONIN WristOx ₂ Soft Sensor – Medium	553020
NONIN WristOx ₂ Soft Sensor – Large	553030
NONIN WristOx ₂ Flex Sensor with 25 Flexi Wraps, 30 cm (12 in) cable – Adult	553130
NONIN WristOx ₂ Wrist Band	564042
WristOx ₂ Wrist Band, Disposable	564050

MASK PRESSURE TUBING

Type	Catalogue Number
Mask tubing 183 cm (72 in) Female x Male, 50 units	552320

USB CABLE

Type	Catalogue Number
USB Type-C Cable	562016

CLEANING

Type	Catalogue Number
PDI Sani-Cloth Plus Germicidal Disposable Cloth	559012
Endozime® AW Plus	NA

Specifications

Nox T3s and Accessories

DESCRIPTION	PROPERTIES
<u>FUNCTION</u>	
Nox T3s Storage Capacity	▶ 4GByte
Nox T3s Recording Time	▶ > 24 hours with new lithium battery
Nox T3s Internal Channels	▶ Two RIP Respiratory Effort ▶ Pressure ▶ Respiratory sound/snoring ▶ Two bipolar (ExG) ▶ Position ▶ Activity ▶ Light
Nox T3s External Channels	▶ Oximeter data via Bluetooth®
<u>PHYSICAL</u>	
Nox T3s Device Dimensions	▶ 68 mm (2.68 in) W, 62 mm (2.44 in) H, 26 mm (1.02 in) D ± 3 mm (0.12 in)
Nox T3s Weight	▶ 70 g ± 3 g without battery
Nox T3s Bipolar Inputs	▶ Touch-proof 1 mm keyhole connector ▶ Input range: $\geq \pm 1024$ mV ▶ Bandwidth: 0–80 Hz (6dB) ▶ Sampling Rate: 200Hz
Nox T3s Pressure Sensor	▶ Pressure input range: -5 cmH ₂ O - +50 cmH ₂ O ▶ Bandwidth: 0-90 Hz (6dB) ▶ Sampling Rate: 200Hz ▶ Connector fitting with Nox Cannula or Nox Filter Tube Connector
Nox Abdomen Cable, s Length	▶ 50 cm (19.69 in)
USB-C Cable	▶ Type of USB connector at device end: Type-C ▶ Type of USB connector at PC end: Standard A

-
- Nox Filter Tube Connector** ▶ Hydrophobic filter with female Luer-lock inlet - diameter of 13 mm (0.51 in), with a 0.45 µm filtering capability

POWER

- Nox T3s Power Source** ▶ One AA battery
▶ Host PC (data configuration and download)

- Nox T3s Battery Type** ▶ Alkaline
▶ Lithium
▶ Rechargeable nickel-metal hydride battery (NiMH)

Nox T3s DISPLAY

- Type** ▶ OLED
- Display Dimensions** ▶ 19.5 mm x 37 mm (0.77 in x 1.46 in)
- Resolution** ▶ 128 dots x 64 dots

Nox T3s TRANSMITTER

- Bluetooth Compliance** ▶ Version 5.0
- Operating Frequency** ▶ 2.402-2.480 GHz
- Output Power** ▶ ≤ 4 dBm
- Network Topology** ▶ Point-to-Point: Point-to-Multipoint
- Operation** ▶ Scatter-Net Master
- Antenna Type** ▶ Internal
- Modulation Type** ▶ Frequency Shift Keying/Frequency Hopping Spread Spectrum
- Transfer Rate** ▶ 2 Mbps

Nox T3s SAMPLING RATE

- Thorax and Abdomen RIP** ▶ 200 Hz
- Microphone** ▶ 8 kHz
- Oximeter - Pleth** ▶ 75 Hz

BANDWIDTH

- Microphone** ▶ Internal 3.5 kHz bandwidth

Material Information

COMPONENT	MATERIAL CONTENT
Nox T3s Recorder	<ul style="list-style-type: none"> ▶ Enclosure: Acrylonitrile butadiene styrene (ABS)/ polycarbonate (PC) ▶ Screen: Polycarbonate (PC) ▶ Proxy: ABS/PC ▶ Snaps: Gold plated stainless steel ▶ Clips: TPU/TPE and nickel-plated steel
Nox Abdomen Cable	<ul style="list-style-type: none"> ▶ Cable wire: Tinsel ▶ Cable jacket: PVC ▶ Abdomen and thorax plastic enclosures: PC/ABS ▶ Snaps: Gold-plated stainless steel ▶ Strain relief for device end: TPE ▶ Strain relief for belt end: PVC ▶ Contact springs in the device end: spring steel
Nox Snap on electrode cables, Bipolar	<ul style="list-style-type: none"> ▶ Cable Jacket: PVC ▶ Cable wire: Tinsel ▶ Connector: Gold-plated spring socket contacts, Riteflex® ▶ Snap: Nickel-plated brass socket, Riteflex®
Nox Snap on electrode cables, Unipolar	<ul style="list-style-type: none"> ▶ Cable Jacket: PVC ▶ Cable wire: Tinsel ▶ Connector: Gold-plated spring socket contacts, Riteflex® ▶ Snap: Nickel-plated brass socket, Riteflex®
Nox T3s Carry Case	<ul style="list-style-type: none"> ▶ External Part: BLK 600D POLYESTER ▶ Internal Part: PU ▶ Insert: ABS
Nox Disposable RIP Belts	<ul style="list-style-type: none"> ▶ Belt Elastic: Polyester/Dorlastan ▶ Connector: ABS ▶ Belt Wire: Tin plated copper

Security Information

The Nox T3s Recorder complies with the following security standards and guidelines:

- IEC 81001-5-1:2021 Health software and health IT systems safety, effectiveness and security – Security - Activities in the product life cycle
- ANSI/AAMI SW96:2023 Standard for Medical Device Security – Security Risk Management for Device Manufacturers

Nox T3s Recorder Ecosystem / User Environment

AMBULATORY SETUP

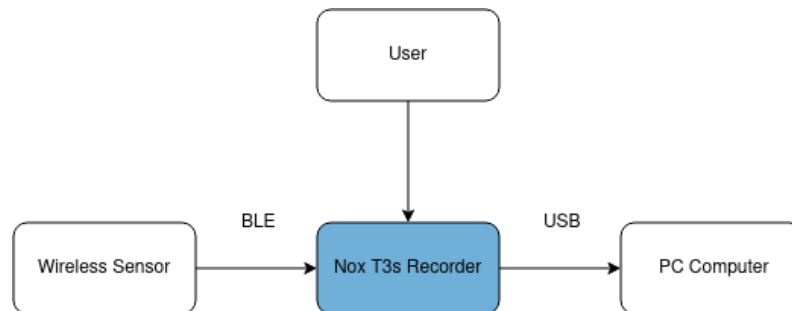

The following interface is provided for configuring and downloading data from the Nox T3s Recorder internal storage:

- USB 2.0 (USB-C Connector)

For IT environments that restrict USB port access to USB peripherals, the following vendor id (VID) and product id (PID) should be allowed on the network for communicating with Nox recorder devices: VID=0x1E0A, PID=0x1002.

The following interface is used for configuring and reviewing (Wireless Sensor):

- Bluetooth Low Energy (BLE, 5.0 and later)

DATA AT REST

All Personally Identifiable Information (PII) is encrypted on the internal Nox T3s Recorder storage. The time series data is stored in a proprietary file format and does not contain any PII.

DATA IN TRANSIT

Bluetooth Low Energy (BLE) communication channels are encrypted to safeguard data transmission according to BLE industry standards.

Data transfer through the USB follows the USB communication protocol standard and is not encrypted.

SECURITY UPDATES

All vulnerabilities notified / detected are assessed using the CVSS¹. The score ranges between 0 and 10 and Security Updates are issued according to the following:

- CVSS 9.0-10.0: Critical – do not use the device until the vulnerability has been patched.
- CVSS 7.0-8.9: High – Fix within 1 month.
- CVSS 4.0-6.9: Medium – Fix within 3 months.
- CVSS 0.1-3.9: Low – Fix within 6 months.
- CVSS 0: None – No action.

Security updates are delivered via distributors as soon as they are released. All installation packets are digitally signed by Nox Medical to ensure security and integrity of the installer content.

VULNERABILITIES

No vulnerabilities have been identified that can affect cybersecurity or safety of the device.

The vulnerability process used complies with the ANSI/AAMI SW96:2023 Standard for medical device security using methods described in the AAMI TIR57:2016 guidance – Principles for medical device security.

SOFTWARE BILL OF MATERIALS (SBOM)

The Software Bill of Material (SBOM) is provided as an IFU Addendum to this document and is available upon request. The SBOM may be maintained more regularly than the product under scope and it is therefore recommended to use the latest version when reviewing the content.

Please reach out to support@noxmedical.com for full disclosure of the latest version of the Software Bill of Material for the product. The Software Bill of Material is updated with every product release / patch / Vulnerability detection and is available both in a human readable and a machine-readable format.

DECOMMISSIONING

To remove all data from the Nox T3s Recorder, connect the device to a computer via USB and format the disc. This can be done in the Noxturnal software with the Factory Reset function.

¹ The Common Vulnerability Scoring System (CVSS) is a method used to supply a qualitative measure of severity.

Regulatory Information

Performance Testing and Validation Summary

The Nox T3s system has been tested and verified in various phases to include internal testing, verification, and validation as well as external testing to assure product safety, effectiveness, and reliability. The design was verified and validated, including clinical evaluation, throughout the design process, according to requirement specifications and intended use. An external accredited test house was used to conduct testing needed to comply with the applicable standards regarding Electromagnetic Compatibility (EMC) and patient safety as well as additional RF testing to assure compliance with Federal Communications Commission (FCC).

The compliance of the Nox T3s system towards patient safety and medical device standards has ONLY been verified and validated with the sensors and accessories listed in this manual. This includes all signal characteristics and automatic analysis provided by the Nox T3s system.

Furthermore, use of other components than verified, validated or recommended by Nox Medical is considered to be a modification of the Nox T3s system. Such modifications could result in the system not performing as intended and cause serious harm to the patient.

Nox Medical holds an ISO 13485:2016 (MDSAP) certified Quality Management System which complies with the requirements of the Medical Device Directive (MDD - Council Directive 93/42/EEC as amended by Directive 2007/47/EC); Canada – Medical Devices Regulations – Part 1 – SOR 98/282; Australia – Therapeutic Goods (Medical Devices) Regulations, 2002, Schedule 3 Part 1 (excluding Part 1.6) – Full Quality Assurance Procedure; Japan – MHLW MO No 169 (2004), as amended by MHLW MO No 60 (2021); PMD Act and USA – 21 CFR 820, 21 CFR 803, 21 CFR 806, 21 CFR 807 – Subparts A to D.

Nox T3s Classifications



- ▶ Degree of protection (applied part) against electric shock: The entire device is an applied part and is classified as of **type BF** (see symbol to the left).
- ▶ Powering of the device: The device is **internally powered**.
- ▶ Degree of protection against harmful ingress of liquids and particulate matter:
 - **The Nox T3s recorder is classified IP22**, i.e. as defined by the standard IEC 60529 it is protected against solid foreign objects of 12.5 mm diameter and greater and vertically falling water drops when enclosure tilted up to 15°. It is not protected against spraying or splashing of water.
- ▶ Method of sterilization: The device is **NOT delivered sterile or intended to be sterilized**.
- ▶ Suitability for use in an oxygen rich environment: The device is **NOT intended for use in an oxygen rich environment**.
- ▶ Suitability for use with flammable agents and anesthetics: The device is **NOT intended for use in conjunction with flammable agents or with flammable anesthetic mixture with air or with oxygen or nitrous oxide**.
- ▶ Mode of operation: The device is intended for **continuous operation**.

Description of Symbols and Labels



Operating instructions / Consult instructions for use



Manufacturer information



Country of manufacture and date of manufacture



Do not re-use



Serial number



Batch code / Lot number



Catalogue number / Reference number



Unique device identifier

(01)1569431111XXXX(11)YYMMDD(21)WWWWW
WWWWW

(01)1569431111XXXX(11)YYMMDD(10)ZZZZZ

Unique Device Identifier (UDI); the Application Identifier (01) represents the device identifier (DI) (“1569431111XXXX”), the Application Identifier (11) the production date/date of manufacture (“YYMMDD”, with “YY” the last two digits of the production year, “MM” the production month and “DD” the production day), the Application Identifier (21) the serial number of the device (“WWWWWWWWWW”) if applicable, and the Application Identifier (10) the lot number of the device (“ZZZZZ”) if applicable



Unique Device Identifier (UDI) presented in data matrix format



Rfid containing UDI information



Type BF applied part (patient isolation from electric shock)



Non ionizing radiation. Equipment includes RF transmitter: interference may occur in the vicinity of equipment marked with this symbol



Federal Communications Commission (FCC) logo



CE marking indicating conformance to the applicable EU regulations/directives

Nox T3s

Brand name/Model name

ASDB1SUS

Technical name

Contains FCC ID: V5A-NOXBLEMOD

FCC ID label



Bluetooth wireless technology

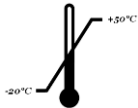

Temperature limit



Humidity limitation

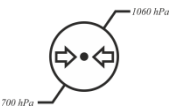

Atmospheric pressure limitation



Keep dry



Fragile, handle with care

IPN₁N₂

Degree of protection against harmful ingress of water or particulate matter as defined by the standard IEC 60529, where N₁ defines the degree of protection against solid foreign objects and N₂ the degree of protection against ingress of water



Unsafe for MR (Magnetic Resonance) Environment.



Medical Device

Bluetooth® Wireless Technology

The Nox T3s recorder uses Bluetooth® 5.0 wireless technology to receive signals from external Bluetooth modules.

The Bluetooth wireless technology is based on a radio link that offers fast and reliable transmission of data. Bluetooth radio uses globally available frequency range in the industrial, scientific and medical (ISM) band, intended to ensure communication compatibility worldwide and a fast acknowledgement and frequency-hopping scheme to make the link robust, even in noisy radio environments. Please refer to the section “Specifications” for details on Radio Frequency (RF) specifications for the Nox T3s recorder.

The *Bluetooth*® word mark and logos are registered trademarks owned by the Bluetooth SIG, Inc. and any use of such marks by Nox Medical is under license. Other trademarks and trade names are those of their respective owners.

Electromagnetic Compatibility (EMC) Information



- ▶ Caution: Exposure to radio frequency radiation.
- ▶ Portable and mobile Radio Frequency (RF) communications can affect the performance of the Nox T3s recorder.
- ▶ Warning: Portable RF communications equipment (including peripherals such as antenna cables and external antennas) should be used no closer than 30 cm (12 inches) to any part of the Nox T3s System, including cables specified by the manufacturer. Otherwise, degradation of the performance of this equipment could result.
- ▶ Warning: Electromagnetic interference (EMI) can be picked up by the Nox T3s recorder, causing disturbed or altered signals to appear in the Noxturnal US software. This may affect data analysis and result in incorrect interpretation of data.
- ▶ Warning: The Nox T3s recorder(s) should not be used adjacent to or stacked with other equipment. If adjacent or stacked use is necessary, the device(s) should be observed to verify normal operation in the configuration in which it will be used and prevent abnormal operation which might cause injuries to the operator/patient.
- ▶ Warning: The use of accessories, transducers, sensors, and cables other than those listed in this manual may result in increased emission and/or decreased immunity of the Nox T3s recorder and cause injuries to the operator/patient.
- ▶ Warning: The Nox T3s system may be interfered with by other equipment, even if that equipment complies with CISPR (Special International Committee on Radio Interference) emission, causing possible patient harm.
- ▶ Refer to the tables below in this section for specific information regarding the Nox T3s recorder’s compliance to the standard IEC 60601-1-2: Medical electrical equipment - Part 1-2: General requirements for basic safety and essential performance - Collateral Standard: Electromagnetic disturbances - Requirements and tests.

Declarations of Conformity with the US Federal Communications Commission (FCC)



Caution: Any changes or modifications to the equipment not expressly approved by Nox Medical could void user’s authority to operate the equipment.

This device complies with Part 15 of FCC Rules, operation is subject to following two conditions:

- (1) This device may not cause harmful interference, and
- (2) This device must accept any interference received including interference that cause undesired operation.

FCC Radiation Exposure Statement:

Co-location of this device with other transmitter that operate simultaneously are required to be evaluated using the FCC multi-transmitter procedures.

This device complies with the safety requirements for RF exposure for portable use conditions in accordance with FCC rule part 2.1093 and KDB 447498 D01.

Compliance to the standard IEC 60601-1-2: Medical electrical equipment - Part 1-2: General requirements for basic safety and essential performance - Collateral Standard: Electromagnetic disturbances - Requirements and Tests.

ELECTROMAGNETIC EMISSIONS

The Nox T3s recorder is intended for use in the electromagnetic environment specified below. The customer or the user of the device should assure that it is used in such an environment.		
Emissions test	Compliance	Electromagnetic environment – guidance
RF emissions CISPR 11	Group 1	The device is suitable for use in all establishments, including domestic establishments and those directly connected to the public low-voltage power supply network that supplies buildings used for domestic purposes.
RF emissions CISPR 11	Class B	
Harmonic emissions IEC 61000-3-2	Not applicable	
Voltage fluctuations/ flicker emissions IEC 61000-3-3	Not applicable	

ELECTROMAGNETIC IMMUNITY

The Nox T3s recorder is intended for use in the electromagnetic environment specified below. The customer or the user of the device should assure that it is used in such an environment.

Immunity test	IEC 60601 test level	Compliance level
Electrostatic discharge (ESD) IEC 61000-4-2	±8 kV contact ±2 kV, ±4 kV, ±8 kV and ±15 kV air	±8 kV contact ±2 kV, ±4 kV, ±8 kV and ±15 kV air
Electrical fast transients/bursts IEC 61000-4-4	± 2 kV for power supply lines ± 1 kV for input/output parts port 100 kHz repetition frequency	Not applicable
Surges IEC 61000-4-5	±0,5 kV, ±1 kV line-to-line ±0,5 kV, ±1 kV, ±2 kV lines-to-ground	Not applicable
Voltage dips IEC 61000-4-11	0 % U_T for 0,5 cycle at 0°, 45°, 90°, 135°, 180°, 225°, 270° and 315°. 0 % U_T for 1 cycle 70 % U_T for 25/30 cycles	Not applicable
Voltage Interruptions IEC 61000-4-11	0 % U_T for 250/300 cycles	Not applicable
Rated power frequency magnetic field IEC 61000-4-8	30 A/m 50 or 60 Hz	30 A/m 60 Hz
Conducted disturbances induced by RF fields IEC 61000-4-6	3 V 0,15 MHz to 80 MHz 6 V in ISM and amateur radio bands between 0,15 MHz and 80 MHz 80% AM at 1 kHz	3 V 0,15 MHz to 80 MHz 6 V in ISM and amateur radio bands between 0,15 MHz and 80 MHz 80% AM at 1 kHz
Radiated RF EM fields IEC 61000-4-3	10 V/m 80 MHz to 2.7 GHz 80% AM at 1 kHz	10 V/m 80 MHz to 2.7 GHz 80% AM at 1 kHz
Proximity fields from RF wireless communications equipment IEC 61000-4-3	Refer to Immunity to proximity fields from RF wireless communications equipment	Refer to Immunity to proximity fields from RF wireless communications equipment
NOTE U_T is the a.c. mains voltage prior to application of the test level.		

IMMUNITY TO PROXIMITY FIELDS FROM RF WIRELESS COMMUNICATIONS EQUIPMENT

The Nox T3s recorder is intended for use in the electromagnetic environment specified below. The customer or the user of the device should assure that it is used in such an environment.

Test Frequency (MHz)	Band (MHz)	Service	Modulation	Maximum power (W)	Distance (m)	Immunity Test Level (V/m)	Compliance (Yes/No)
385	380-390	TETRA 400	Pulse modulation 18Hz	1,8	0,3	27	Yes
450	430-470	GMRS 460, FRS 460	FM ±5 kHz deviation 1 kHz sine	2	0,3	28	Yes
710	704-787	LTE Band 13, 17	Pulse modulation 217 Hz	0,2	0,3	9	Yes
745							
780							
810	800-960	GSM 800/900, TETRA 800, iDEN 820, CDMA 850, LTE Band 5	Pulse modulation 18 Hz	2	0,3	28	Yes
870							
930							
1720	1700- 1990	GSM 1800; CDMA 1900; GSM 1900; DECT; LTE Band 1, 3, 4, 25; UMTS	Pulse modulation 217 Hz	2	0,3	28	Yes
1845							
1970							
2450	2400- 2570	Bluetooth, WLAN, 802.11 b/g/n, RFID 2450, LTE Band 7	Pulse modulation 217 Hz	2	0,3	28	Yes
5240	5100- 5800	WLAN 802.11 a/n	Pulse modulation 217 Hz	0,2	0,3	9	Yes
5500							
5785							