

nox medical

NOX A1s

MANUAL

English

Nox A1s Manual

Version 1.0

Latest Revision: March 2021

Copyright © 2021

Nox Medical - All rights reserved

Manufactured by:

Nox Medical ehf

Katrinartuni 2

IS - 105 Reykjavik

Iceland

Website: www.noxmedical.com

nox medical

For distributor information go to:

www.noxmedical.com

CE 2797

Copyright Notice

No part of this publication may be reproduced, transmitted, transcribed, stored in a retrieval system, or translated into any language or computer language, in any form, or by any means: electronic, mechanical, magnetic, optical, chemical, manual, or otherwise, without the prior written authorization from Nox Medical.

License Notice

The Nox A1s recorder's firmware contains BIGDIGITS multiple-precision arithmetic code originally written by David Ireland, copyright © 2001-8 by D.I. Management Services Pty Limited <www.di-mgt.com.au>, and is used with permission.

Table of Contents

| | |
|--|----|
| Table of Contents | 3 |
| List of Abbreviations | 5 |
| Introduction | 7 |
| Intended Use..... | 7 |
| Contraindications..... | 7 |
| Scope..... | 7 |
| Instructions for Operators | 8 |
| Warnings and Cautions for Use | 9 |
| Nox A1s Description | 12 |
| Nox A1s Interface..... | 12 |
| Operating Nox A1s..... | 15 |
| Connecting Nox A1s to a Computer..... | 15 |
| Configuring and Downloading from Nox A1s..... | 16 |
| Manually Starting/Stopping Nox A1s..... | 16 |
| Starting Nox A1s at a Scheduled Time | 17 |
| Nox A1s Status | 17 |
| Nox A1s Patient Hookup..... | 20 |
| Inserting a Battery to the Nox A1s..... | 20 |
| Attaching the Nox A1s and the Nox RIP Belts | 21 |
| Attaching the Nox Nasal Cannula | 23 |
| Measuring Mask Pressure..... | 24 |
| Measuring EEG Signals..... | 24 |
| Measuring EMG/ECG Signals | 26 |
| Measuring Pulse and Oxygen Saturation using Nonin WristOx2 Pulse Oximeter, Model 3150 BLE . | 27 |
| Inserting Batteries into the Nonin WristOx2 Pulse Oximeter, Model 3150 BLE | 29 |
| Selecting Oximeter Sensor Size..... | 29 |
| Attaching the Nonin WristOx2 Pulse Oximeter, Model 3150 BLE and Nonin WristOx2 Soft Sensor . | 29 |
| Establishing a Connection between the Nonin 3150 BLE Pulse Oximeter and Nox A1s..... | 31 |

Maintenance..... 38

Compatible Sensors and Devices 43

Specifications..... 47

 Nox A1s and Accessories..... 47

 Material Information 49

 Nox A1s Battery Information 50

Regulatory Information 51

 Performance Testing and Validation Summary 51

 Nox A1s Classifications..... 51

 Description of Symbols and Labels 52

 Bluetooth® Wireless Technology 54

 Electromagnetic Compatibility (EMC) Information..... 54

About 58

List of Abbreviations

| | | |
|-------|---|---|
| AASM | - | American Academy of Sleep Medicine |
| ABS | - | Acrylonitrile Butadiene Styrene |
| BMI | - | Body Mass Index |
| CISPR | - | <i>Comité International Spécial des Perturbations Radioélectriques</i> (English: International Special Committee on Radio Interference) |
| CMDR | - | Canada Medical Device Regulations |
| CPAP | - | Continuous positive airway pressure |
| ECG | - | Electrocardiography |
| EEG | - | Electroencephalography |
| EMG | - | Electromyography |
| EMC | - | Electromagnetic compatibility |
| EOG | - | Electrooculography |
| ESD | - | Electrostatic discharges |
| HF | - | High Frequency |
| IEC | - | International Electrotechnical Commission |
| ISM | - | Industrial, Scientific and Medical |
| MDD | - | Medical Device Directive |
| MRI | - | Magnetic Resonance Imaging |
| NiMH | - | Nickel-metal hydride battery rechargeable |
| PAP | - | Positive Airway Pressure |
| PC | - | Polycarbonate |
| PET | - | Polyethylene Terephthalate |
| PE | - | Polyethylene |
| PG | - | Polygraphy |
| PSG | - | Polysomnography |
| PVC | - | Polyvinyl Chloride |
| RED | - | Radio Equipment Directive |

- RF - Radio Frequency
- RIP - Respiratory Inductance Plethysmography
- SpO2 - Oxygen Saturation Levels measured by pulse oximetry
- TPE - Thermoplastic Elastomer
- WEEE - Europe on Waste of Electrical and Electronic Equipment

Introduction

Congratulations on choosing the Nox A1s recorder. The Nox A1s recorder is a body worn sleep recorder intended to be worn over clothing or pajamas. The Nox A1s recorder is a part of the Nox Sleep System. Its main function is to record physiological signals by use of built-in sensors and patient applied sensors. The Nox A1s recorder has a built-in Bluetooth® module also allowing it to communicate with other Nox Sleep System devices and to record signals from compatible auxiliary devices. The Nox A1s recorder is configured by the Noxturnal software from Nox Medical, running on a PC, that also allows for the review, organization, analyzing, and summarizing of all signals recorded by the device. The complexity of the study is defined by varying the number and types of physiological signals measured, supporting both ambulatory and online sleep testing. During online configuration of the Nox Sleep System, commands and data are sent between the Nox A1s recorder and the Noxturnal software by use of the Nox C1 Access Point from Nox Medical. The Nox A1s recorder can communicate over Bluetooth link, either direct or via the Nox C1 Access Point (depending on the system configuration), with Noxturnal App from Nox Medical running on a mobile platform for device control and online review of signals being recorded.

Intended Use

The Nox Sleep System is used as an aid in the diagnosis of different sleep disorders and for the assessment of sleep.

The Nox Sleep System is used to measure, record, display, organize, analyze, summarize and retrieve physiological parameters during sleep and wake in patients greater than 2 years of age.

The Nox Sleep System allows the user to decide on the complexity of the study by varying the number and types of physiological signals measured.

The Nox Sleep System allows for generation of user/pre-defined reports based on subject's data.

The users of the Nox Sleep System are medical professionals who have received training in the areas of hospital/clinical procedures, physiological monitoring of human subjects, or sleep disorder investigation.

The intended environments are hospitals, institutions, sleep centers, sleep clinics, or other test environments, including patient's home.

Contraindications

The Nox Sleep System does not provide any alarms and is not intended to be used for continuous monitoring where failure to operate can cause injuries or death of the patient.

Scope

This manual covers the use of the Nox A1s recorder and its components along with external sensors and auxiliary devices that have been validated with the Nox Sleep System.

The use of Nox A1 Recorder and its components along with external sensors and auxiliary devices that have been validated with the Nox Sleep System is covered in

- Nox A1 Manual

The pictures below show the different appearance of the Nox A1s Recorder and the Nox A1 Recorder. Please be sure you are following the correct manual for your recorder.



Nox A1 Recorder

Nox A1s Recorder

The use of the Noxturnal software application that is needed for device configuration, data download, review, and analysis as well as the use of the Nox C1 Access Point that is needed for the online setup of the Nox Sleep System are covered in:

- Noxturnal Manual
- Nox C1 Manual

This manual is only intended for professionals (healthcare professionals and service personnel) with relevant qualifications and skills. Additional material can be found on the Nox Medical Website.

Instructions for Operators

The Nox A1s recorder is only intended to be set-up and maintained by professionals (healthcare professionals and service personnel) with relevant qualifications and skills according to the instructions given in the “Operating Nox A1s”, “Nox A1s Patient Hookup” and “Maintenance” sections. The **ONLY** operation that patients might have to perform by themselves at home during a PSG study is to start recordings that have been configured to be manually started¹. In that case, the professional setting up the Nox A1s recorder and hooking up the patient shall demonstrate how to start the recording manually and train the patient to do so according to the “Manually Starting/Stopping a Recording” section.

Operators should contact Nox Medical or its sales representatives

- for assistance, if needed, in setting up, attaching, operating or maintaining the Nox Sleep System, its accessories, and as applicable external sensors and auxiliary devices that have been validated with the system; or
- to report unexpected operation or events.

Support information and information about Nox Medical’s sales representative can be found on Nox Medical’s website: www.noxmedical.com/distributors.

¹ The patient might perform the hook-up on him/herself or with the assistance of a family member when conducting a simple PG study in the home environment (similar as with the Nox T3/Nox T3s recorder). In this case the patient is either instructed how to perform the hookup by a qualified healthcare professional before he/she is sent home with the system or directed to a video file that demonstrates the hook-up process.

Warnings and Cautions for Use

- ▶ **Warning:** The Nox Sleep System **is NOT certified to be used for continuous monitoring** where failure to operate can cause injuries or death of the patient.
- ▶ **Caution:** The Nox A1s recorder complies with the international standard IEC 60601-1-2 for electromagnetic compatibility for medical electrical equipment and/or systems. That standard is designed to provide reasonable protection against harmful interference in a typical medical installation. However, because of the proliferation of radio-frequency transmitting equipment and other sources of electrical noise in healthcare and other environments, it is possible that high levels of interference due to close proximity or strength of source might disrupt the performance of the device, affecting recorded signals and therefore data analysis and resulting in possible incorrect treatment. Medical electrical equipment needs special precautions regarding Electromagnetic Compatibility (EMC), and needs to be installed and put into service according to the EMC information provided in the “EMC Information” section of this manual.
- ▶ **Warning:** The use of accessories, transducers, sensors, and cables other than those listed in this manual may result in increased emissions and/or decreased immunity of the Nox Sleep System and cause injuries to the operator/patient.
- ▶ **Warning:** The Nox A1s recorder(s) should not be used adjacent to or stacked with other equipment. If adjacent or stacked use is necessary, the device(s) should be observed to verify normal operation in the configuration in which it/they will be used and prevent abnormal operation which might cause injuries to the operator/patient.
- ▶ **Warning:** The Nox Sleep System may be interfered with by other equipment, even if that equipment complies with International Special Committee on Radio Interference (CISPR) emission requirements, causing possible patient harm.
- ▶ **Caution:** Exposure to radio frequency radiation.
- ▶ **Caution:** The Nox A1s recorder is designed to be safe for use for pacemaker patients if the pacemakers comply with the standard: EN 45502-2-1 Active implantable medical devices. Particular requirements for active implantable medical devices intended to treat bradyarrhythmia (cardiac pacemakers) and/or EN 45502-2-2 Active implantable medical devices. Particular requirements for active implantable medical devices intended to treat tachyarrhythmia (includes implantable defibrillators). Using non-compliant pacemakers may result in the operation of the pacemaker being affected by the use of Nox A1s recorder and lead to possible patient harm. Prior to using the device with pacemaker patients, the operator should consult the accompanying documents of the pacemaker regarding its certifications and requirements of use or, if necessary, contact the manufacturer.
- ▶ **Warning:** The Nox A1s recorder is not defibrillator proof. Not removing the device from a patient before defibrillation may lead to the creation of high current density at the electrode sites, causing burns and leading to possible patient harm. Not removing the device from a patient before defibrillation may also alter the intended flow of the current, affecting the defibrillation efficiency and causing injuries or death of the patient.
- ▶ **Warning:** The Nox A1s recorder and its accessories are not intended to be used with high frequency (HF) equipment. Using the device with high frequency (HF) equipment could cause potential serious harm to the patient.
- ▶ **Warning:** The Nox A1s EEG Head Cable/ Nox EEG 5 Lead Gold Electrode Cable do not provide protection against the effect of the discharge of a cardiac defibrillator nor against high frequency burns. Not removing the equipment from a patient before defibrillation may lead to the creation of high current density at the electrode sites, causing burns and leading to possible patient harm.

- ▶ Warning: The Nox A1s recorder and accessories are not designed to give a specified degree of protection against harmful ingress of liquids. Do not autoclave or immerse the device in any kind of liquids. Ingress of liquids may result in electric shock.
- ▶ Warning: The Nox A1s recorder is NOT suitable for use in presence of a flammable anesthetic mixture with air or with oxygen or nitrous oxide. That could lead to the creation of electrostatic charges or temperature exceeding limits resulting in sparks or ignition, causing burns or explosions.
- ▶ Warning: Do not use the Nox A1s recorder and accessories during radiography/X-ray studies. The energy absorption in the device, cables or electrodes might lead to excessive heating and cause burns.
- ▶ Warning: As with all medical equipment, carefully route cables and connections to reduce the possibility of entanglement or strangulation.
- ▶ Warning: Do not use any part of the Nox Sleep System, including patient cables and electrodes, in a MRI (Magnetic Resonance Imaging) environment. The energy absorption in conductive materials might lead to excessive heating and cause burns.
- ▶ Caution: The Nox A1s recorder and Nox RIP belts should be worn over clothing to prevent allergic reaction to the equipment materials.
- ▶ Caution: The Nox RIP belts should fit the patient snugly without being uncomfortably tight to avoid discomfort.
- ▶ Warning: The Nox disposable RIP belts, Nox nasal cannula, Nox filter tube connector, Pro Tech Airflow Thermocouple, Ambu Leads with attached electrode, Ambu Snap-on electrodes, Nonin Wristband, and Westmed Mask tubing are single patient use. Using the same disposable RIP belts, cannula, filter tube connector, thermocouple, leads, snap-on electrodes, wristband, and mask tubing on more than one patient poses a risk of cross-infection.
- ▶ Warning: The disposable RIP belts are single use. Reusing the belts may affect the quality of recorded signals and lead to possible incorrect treatment.
- ▶ Warning: Do not use damaged equipment, sensors, or accessories. This may result in bad performance of the Nox Sleep System or patient/operator injury.
- ▶ Warning: The Nox A1s recorder and its accessories should be removed from the patient before use of the USB connector to prevent electrical shock. The USB connector shall only be used for the purposes of configuring the device and downloading data from the device.
- ▶ Warning: There are no user serviceable parts inside the Nox A1s recorder. The device should be serviced by authorized parties only. Service performed by non-authorized parties may affect data analysis and result in possible incorrect treatment. The warranty is void if the Nox A1s recorder is opened (except for opening of the battery compartment).
- ▶ Warning: No modification of the Nox A1s recorder and its accessories is allowed. Un-authorized modifications could result in the device not performing as intended and cause serious harm to the patient. To ensure patient safety and effective use of the Nox Sleep System, only use accessories that have been validated for use by Nox Medical. Refer to section “Compatible Sensors and Devices”.
- ▶ Warning: Remove batteries from the Nox A1s recorder if it is not used within 30 days to prevent damage from possible battery leakage and prevent possible minor burns to the operator/patient.
- ▶ Warning: External equipment and all auxiliary devices intended for connection to signal input, signal output or other connectors shall comply with the relevant product safety standards, e.g. IEC 60950-1 for IT equipment and the IEC 60601 series for medical electrical equipment, to prevent electric shocks. In addition, all such combinations – *systems* – shall comply with the safety requirements stated in the collateral standard IEC 60601-1-1 or the general standard IEC 60601-1, edition 3/3.1, clause 16. Any equipment not complying with the leakage current requirements in IEC 60601-1 shall be kept outside the patient environment i.e. at least 1.5 m from the patient support. Any person who connects external equipment to signal input, signal output or other

connectors has formed a system and is therefore responsible for the system to comply with the requirements. If in doubt, contact qualified medical technician or your local representative.

- ▶ **Warning:** Avoid accidental contact between connected but unused patient applied parts and other conductive parts including those connected to protective earth to prevent potential serious harm to the operator/patient.
- ▶ **Warning:** Make sure the conductive parts of electrodes and associated connectors, including the neutral electrode, do not contact other conductive parts including earth to prevent potential serious harm to the operator/patient.
- ▶ **Warning:** Electrodes should only be used by or in consultation with a healthcare provider familiar with their proper placement and use. Not using and placing the electrodes correctly may affect recording of data, and therefore interpretation and diagnostics.
- ▶ **Warning:** The electrodes should be applied only to intact, clean skin (e.g. not over open wounds, lesions, infected or inflamed areas) to prevent infections.
- ▶ **Warning:** The Nox EEG 5 Lead Gold Electrode Cables should be properly disposed of if they cannot be fully cleaned between uses to prevent the risk of cross-infection between patients.
- ▶ **Warning:** The Nox EEG 5 Lead Gold Electrode Cables are not certified to be used for electrical stimulation purposes. Using the product for electrical stimulation purposes might create burns and cause injuries to the patient.
- ▶ **Caution:** The Nox A1s recorder and its accessories should always be transported in the accompanying carrying case to ensure adequate protection and prevent damage.



- ▶ Please read this manual carefully before use, especially sections marked with an exclamation mark.

Nox A1s Description

The Nox A1s is a body worn sleep recorder. The input channels and built-in capabilities of the device include the following:

- 13 unipolar channels; for recording of electroencephalography (EEG), electrooculography (EOG) and submental electromyography (EMG)
- 1 ground channel
- 4 bipolar channels; for recording of electrocardiogram (ECG), periodic limb movements (PLM), masseter EMG, or other such as additional EMG or airflow
- 1 pressure channel; for recording of nasal or mask pressure
- 2 respiratory effort channels; for recording of abdomen and thorax ventilatory effort signals
- 3-D built-in acceleration sensor; for recording of patient's position and activity
- Built-in light sensor; for recording of ambient light
- Built-in microphone; for recording of audio and snoring
- Built-in Bluetooth® module; to support wireless connectivity allowing the device to record signals from compatible auxiliary devices

During online configuration of the Nox Sleep System the Bluetooth function enables the Nox A1s recorder to communicate with the Noxturnal software and the Noxturnal App via the Nox C1 Access Point for device control and online review of recorded signals.

During ambulatory configuration of the Nox Sleep System, the Bluetooth function enables the Nox A1s recorder to communicate with Noxturnal App for device control and online review of recorded signals.

The Nox A1s recorder is powered with one AA battery.

Nox A1s Interface

The Nox A1s recorder interface consists of a display, button, sensor inputs/connections, indicator light and a USB connector. The USB connector is placed under the battery lid and connects to Nox USBc cable for device configuration and data download. See the figures and tables below for detailed description.

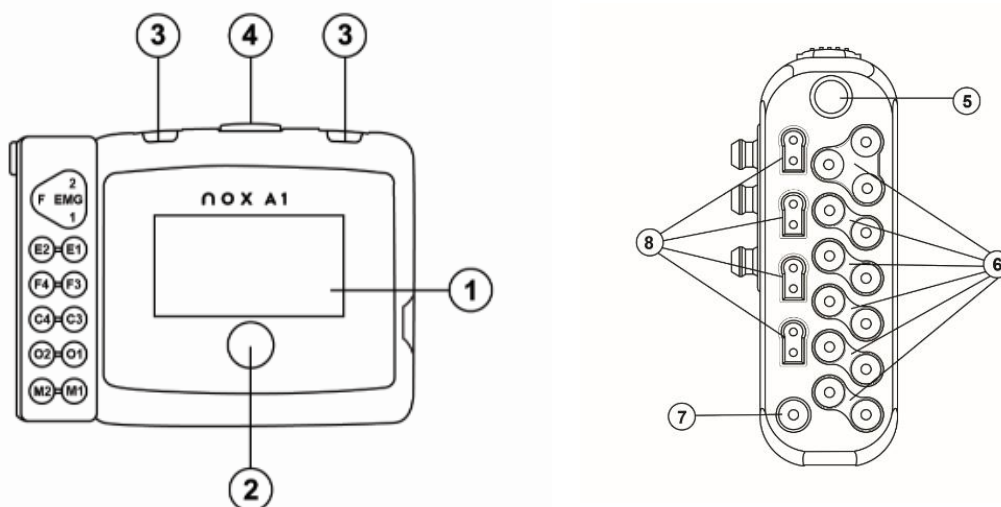

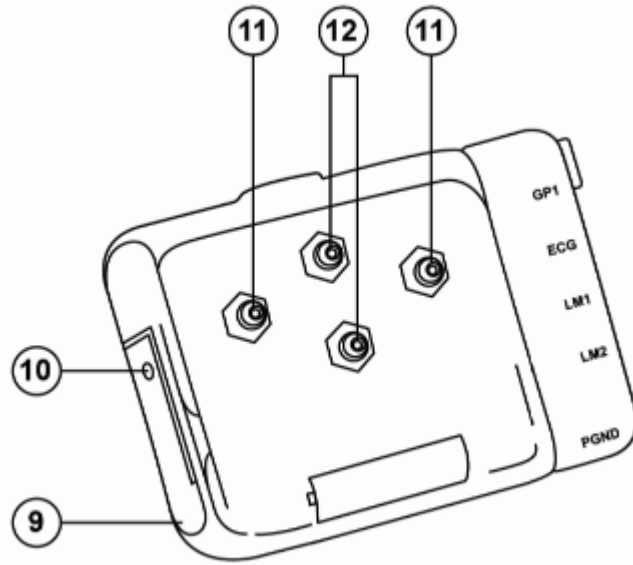

| NUMBE R | FUNCTION | INPUT/SENSOR LABEL |
|------------|--|--|
| 1 | Display | NA |
| 2 | Push button | NA |
| | Light sensor located under the push button | |
| 3 | Indicator light for device status in the push button 2 Clip strap loops | NA |
| 4 | Microphone – For recording of respiratory sounds | NA |
| 5 | 1 Pressure lock – Connects to nasal cannula/mask pressure tube | PRES: Pressure input connector |
| 6 | 13 Unipolar touch proof inputs (10 EEG/EOG, 3 chin EMG) | <ul style="list-style-type: none"> • EMG: 1,2, F – Electromyography (EMG) input connectors • E2-E1, F4-F3, C4-C3, O2-O1, M2-M1: Electroencephalography (EEG) and electrooculography (EOG) input connectors |
| 7 | 1 Reference ground input | <ul style="list-style-type: none"> • PGND: Patient ground |
| 8 | 4 Bipolar touch proof inputs | <ul style="list-style-type: none"> • GP1: General purpose bipolar input connector • ECG: Electrocardiography (ECG) input connectors • LM1, LM2: Electromyography (EMG) input connectors |
| 9 | Battery lid – Covers the battery and the USB connector | NA |

| | | |
|----|---|----|
| 10 | Battery lid pin | NA |
| 11 | 2 Metal snaps – Connects to thorax RIP belt | NA |
| 12 | 2 Metal snaps – Connects to abdomen cable | NA |

Operating Nox A1s

The Nox A1s recorder is only intended to be operated by professionals (healthcare professionals and service personnel) with relevant qualifications and skills. The **ONLY** operation that patients might have to perform by themselves at home² is to start recordings that have been configured to be manually started. In that case, the professional setting up the Nox A1s recorder and hooking up the patient shall demonstrate how to start the recording manually and train the patient to do so according to the “Manually Starting/Stopping a Recording” section.

The Nox A1s recorder is operated with one push button located on the front panel. Pressing the button turns on the display. The display will automatically turn off in 3 minutes.

Connecting Nox A1s to a Computer



- ▶ **Warning:** The Nox A1s recorder and its accessories should be removed from the patient before use of the USB connector to prevent electrical shock. The USB connector shall only be used for the purposes of configuring the device and downloading data from the device.

To connect Nox A1s recorder to a computer you need to access the USB connector on the device. The USB connector is placed under the battery lid making it inaccessible and tamper proof for children. To open the battery lid, press with the Nox battery Lid Key, accompanying the Nox A1s System Kit, on the battery lid pin and slide the battery lid down, towards the bottom of the device. The Nox A1s recorder connects to the computer by using Nox USBc cable. The battery does not have to be inserted while the device is connected to the computer.

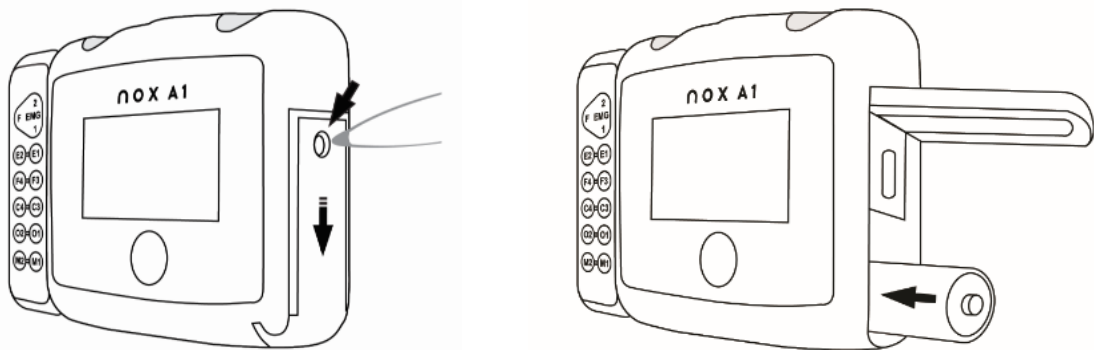

When the Nox A1s recorder is connected to the computer the device display lights up and a message saying the device is connected to the computer.

² The patient might perform the hook-up on him/herself or with the assistance of a family member when conducting a simple PG study in the home environment (similar as with the Nox T3/Nox T3s recorder). In this case the patient is either instructed how to perform the hookup by a qualified healthcare professional before he/she is sent home with the system or directed to a video file that demonstrates the hook-up process.

Configuring and Downloading from Nox A1s

To download a recording or configure the Nox A1s recorder you will need to start the Noxturnal software application and connect the device to the computer. Please refer to the Noxturnal manual for more information on how to perform those tasks.

When you are done working with the device eject it from the Noxturnal software and unplug the Nox USB-C cable. Insert the battery and close the battery compartment by pressing the lid back towards the device without causing any strain, then slide it back into position, towards the top of the device.

Manually Starting/Stopping Nox A1s

If the Nox A1s recorder has been configured to start the recording manually, you can use the button to manually start a recording. Pressing the button turns on the display. The device will instruct you to “Hold button to record”. Please do so until you see “Recording Duration” displayed. Note the button needs to be pressed down for approximately 4-5 s before “Recording Duration” displays. At this point the device has started to record data and the REC symbol appears at the top of the screen. After the display turns off, the light under the button will blink green intermittently indicating that a recording is taking place. Use the same method to manually stop the recording.



If the duration of the recording has been specified during configuration, the recording will automatically stop after the specified duration.

Starting Nox A1s at a Scheduled Time

If the Nox A1s recorder has been configured to automatically start a recording at a scheduled time, there are no actions required for the recording to start. Pressing the button before the recording has started will display a countdown to the specified start time of the recording. If the recording has begun, the display shows the current duration of the recording and the REC symbol appears on the top of the screen.



Nox A1s Status

Indicator Light

The indicator light on the Nox A1s recorder blinks green when a recording is in progress and the device is functioning normally. When there are any device warnings the indicator light blinks amber. Warnings might include:

- Battery low
- Device not licensed.

Displays

Information about the recording duration, recording status and device connections is shown on the display. If the display is turned off, pressing the button turns it on. By pressing the button again, you will loop through the available displays. The display will turn itself off again after being inactive for 2 minutes.

The display includes information about device connection, time and battery status.

1. A Bluetooth symbol and an “X” or a checkmark “ ” are visible on all displays. This symbol shows the status of the Bluetooth connection with the oximeter. An “X” means there is not Bluetooth connection, a “ ” means there is a Bluetooth connection.
2. The device’s clock. When Nox A1s is configured, the clock is synchronized with the PC and is shown at the top of the display.
3. On the top right corner is a battery indicator which shows the battery status. The battery indicator is full when the device has fresh batteries.



The first display that shows up after the device is turned on shows information about the recording planned or ongoing as explained in previous sections. The second display shows the status of the oximeter connection.

1. An “X” next to SpO₂ indicates that the oximeter is not connected to the device. Once an oximeter has been connected, a checkmark “ ” will appear.
2. The Bluetooth device address (BDA) of the oximeter that the device is trying to connect to or is connected to.



The third display shows the status of scheduled recordings. It only appears if the device is configured for 2 or 3 scheduled recordings.

1. Status of scheduled recordings. The number of squares represent the number of recordings scheduled. A full square represents a recording that has already been recorded successfully. An empty square represents a recording yet to be performed.



Examples of the multiple night status indicator and their meanings can be seen below:



Three empty squares: The device has been configured to record three nights, but no recording has been performed.



Three squares, the first one full: The device has been configured to record three nights, and one night has been recorded successfully.

Nox A1s Patient Hookup



- ▶ **Warning:** Do not use damaged equipment, sensors, or accessories. This may result in bad performance of the Nox Sleep System or patient/operator injury.
- ▶ **Warning:** As with all medical equipment, carefully route cables and connections to reduce the possibility of entanglement or strangulation.
- ▶ **Caution:** The Nox A1s recorder and its accessories should always be transported in its accompanying carrying case to ensure adequate protection and prevent damage.

The Nox A1s recorder is only intended to be hooked-up by professionals (healthcare professionals and service personnel) with relevant qualifications and skills³.

Inserting a Battery to the Nox A1s

The list below is provided to assist the user in selecting the appropriate battery type for a Nox A1s study:

- Alkaline batteries can be used to record from 10 to 12 hours depending on battery type.
- Lithium batteries can be used to record from 20 to 30 hours depending on study type and battery.
- Rechargeable NiMH batteries can be used to record for 1 hour to 1.5 hours per 200 mAh capacity. Thus, a standard 2000 mAh battery can record from 10 to 15 hours.



- ▶ **Note:** Always use fully charged **Powerex 2700 mAh Rechargeable Batteries, high quality alkaline batteries of at least 2000mAh capacity** or fresh **lithium battery** for each recording to prevent the need for the sleep study to be repeated.
- ▶ **Note:** All lithium batteries used with the Nox A1s recorder shall be per the standard IEC 60086-4 Primary batteries - Part 4: Safety of lithium batteries.

Before you start a recording, you should make sure that the Nox A1s recorder has a new or fully charged battery. To insert a new battery, do the following:

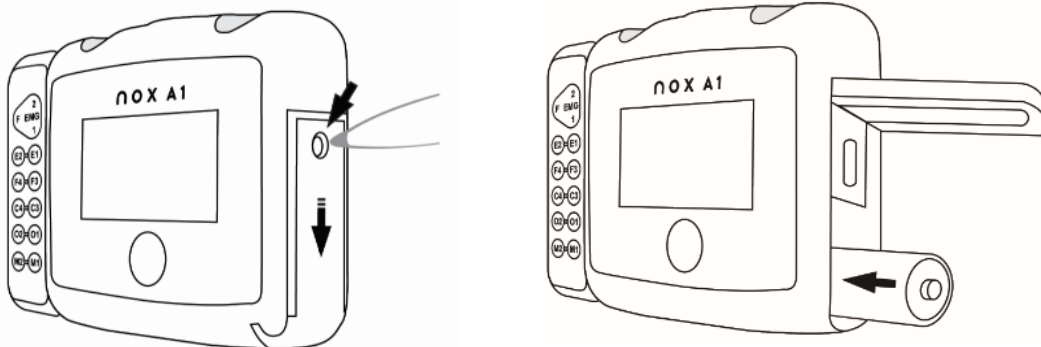

³ The patient might perform the hook-up on him/herself or with the assistance of a family member when conducting a simple PG study in the home environment (similar as with the Nox T3/Nox T3s recorder). In this case the patient is either instructed how to perform the hookup by a qualified healthcare professional before he/she is sent home with the system or directed to a video file that demonstrates the hook-up process.

1. Open the battery compartment by pressing down the battery lid pin with the Nox Battery Lid Key accompanying the Nox A1s System Kit or similar tool and slide the lid towards the bottom of the device.
2. Place one AA battery in the compartment aligning the battery poles as illustrated on the back of the device (the positive (+) pole is towards the battery lid).
3. Close the battery compartment by pressing the lid back towards the device without causing any strain, then slide it back into position, towards the top of the device. Make sure the lid is securely closed.

The status of the battery can be checked by turning on the device. The battery status indicator positioned in the upper right-hand corner of the device display allows you to check the battery status. When the battery is running low during a recording the device will automatically stop the recording.

Attaching the Nox A1s and the Nox RIP Belts



- ▶ Caution: The Nox A1s recorder and Nox disposable RIP belts should be worn over clothing to prevent allergic reaction to the equipment materials.
- ▶ Warning: The Nox disposable RIP belts are single use and single patient use. Re-using the disposable RIP belts may affect the quality of recorded signals and lead to possible incorrect treatment. Using the same disposable RIP belt on more than one patient poses a risk of cross-infection.

Step 1

Snap the clips that are attached to the Nox A1s recorder to the patient's shirt.

1

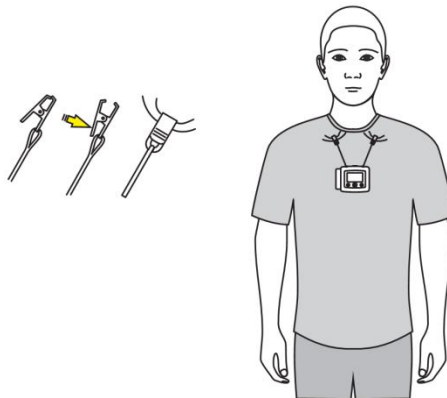

Step 2 to Step 4

- Snap the Nox abdomen cable to the back of the device.
- Place a Nox disposable RIP belt around the thorax and snap its ends to the back panel of the device.
- Adjust the Nox abdomen cable length as needed by wrapping it around the abdomen connection unit. Place a Nox disposable RIP belt around the abdomen and snap it in place.

2

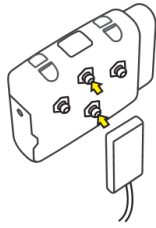

3

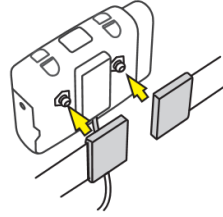

4

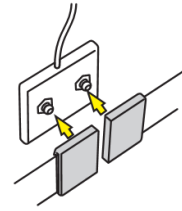

Step 5

Attaching the Nox A1s recorder and Nox disposable RIP belts is now completed.

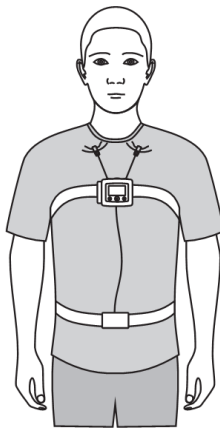

Adjusting the Nox RIP Belts



- ▶ **Caution:** The Nox disposable RIP belts should fit the patient snugly without being uncomfortably tight to avoid discomfort.
- ▶ **Note:** For most patients, the Nox disposable RIP belts do not need to be adjusted if the correct belt size is chosen based on the patient's abdomen circumference and/or body mass index (BMI). Belt size selection tables accompany Nox disposable RIP belts packages for more detailed instruction.

Fit the Nox disposable RIP belts around the patient's waist and thorax and adjust the length using the loop on each end to adjust the belt length such that the belt covers about two thirds of the patient's circumference when the belt is unstretched. The length is fixed with hooks on the plastic connector of the belt.

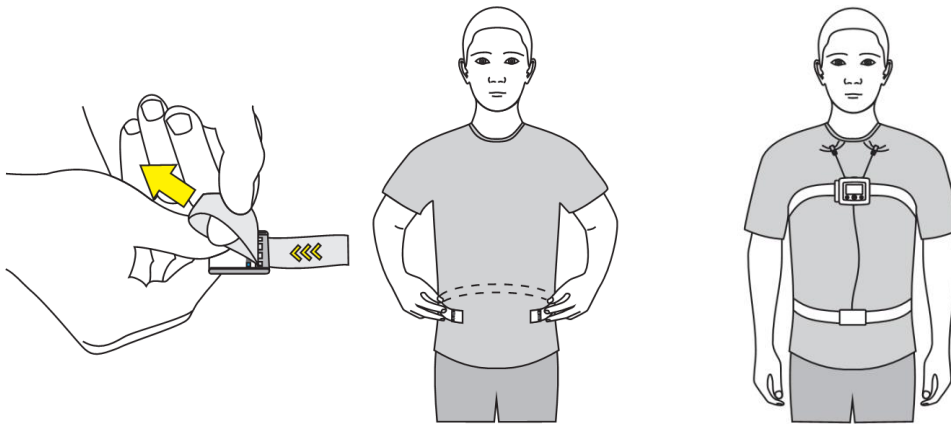

Attaching the Nox Nasal Cannula



- ▶ **Warning:** The Nox nasal cannulas are single patient use. Using the same nasal cannula on more than one patient poses a risk of cross-infection.
- ▶ **Note:** Medical tape can be used to hold the cannula against the cheeks to secure the cannula in place if necessary.
- ▶ **Note:** The Nox nasal cannula with filter has a built-in hydrophobic filter and is the preferred way to measure nasal airflow and snoring as it is designed to maximize the signal quality and fits directly with the Nox A1s recorder.

Step 1

Place the nasal prongs gently in the nostrils. The prongs should point downwards inside the nostrils.

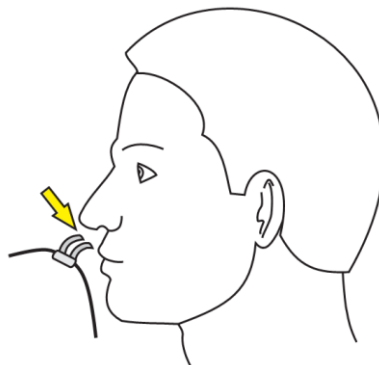

Step 2

Pull the cannula tubing over the ears and then position it under the chin.

Step 3

Slide the fastener snugly under the chin to hold the cannula tubing securely in place.

1

2

3

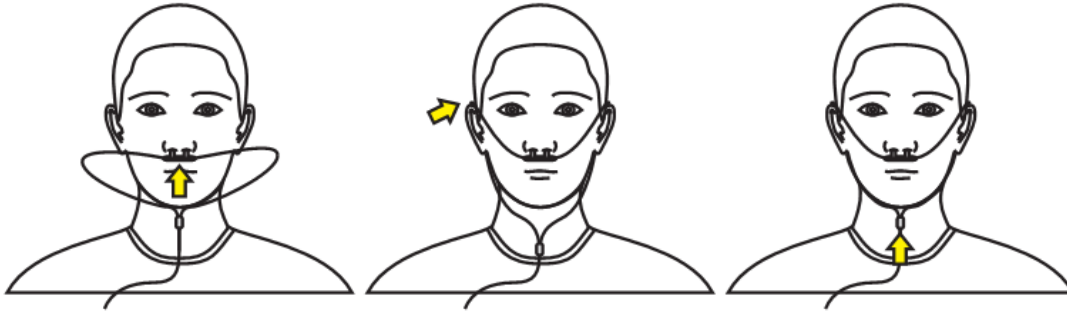

Measuring Mask Pressure



- ▶ **Warning:** The mask pressure tubes and Nox filter tube connectors are single patient use. Using the same mask pressure tube and filter tube connector on more than one patient poses a risk of cross-infection.
- ▶ **Note:** The mask pressure tube can only be connected to the pressure lock on the Nox A1s recorder by using the Nox filter tube connector.

A mask pressure tube is used for connection to positive airway pressure (PAP) masks for measuring mask pressure. The pressure tube connects to the pressure lock on the Nox A1s recorder via a filter tube connector from Nox Medical.

Refer to the “Compatible Sensors and Devices” section regarding the types of mask pressure tubes that have been validated with the Nox A1s recorder.

Measuring EEG Signals



- ▶ **Warning:** Electrodes should only be used by or in consultation with a healthcare provider familiar with their proper placement and use. Not using and placing the electrodes correctly may affect recording of data, and therefore interpretation and diagnostic.
- ▶ **Warning:** The electrodes should be applied only to intact, clean skin (e.g. not over open wounds, lesions, infected or inflamed areas) in order to prevent infections.
- ▶ **Warning:** Make sure the conductive parts of electrodes and associated connectors, including the neutral electrode, do not contact other conductive parts including earth to prevent potential serious harm to the operator/patient.
- ▶ **Warning:** The Nox EEG 5 Lead Gold Electrode Cables should be properly disposed of if they cannot be fully cleaned between uses in order to prevent the risk of cross-infection between patients.
- ▶ **Warning:** The Nox EEG 5 Lead Gold Electrode Cables are not certified to be used for electrical stimulation purposes. Using the product for electrical stimulation purposes might create burns and cause injuries to the patient.
- ▶ **Warning:** The Nox A1s EEG Head Cable/ Nox EEG 5 Lead Gold Electrode Cables do not provide protection against the effect of the discharge of a cardiac defibrillator nor against high frequency burns. Not removing the equipment from a patient before defibrillation may lead to the creation of high current density at the electrode sites, causing burns and leading to possible patient harm.

Connect the Nox A1s EEG Head Cable to the E2-E1, F4-F3, C4-C3, O2-O1, M2-M1 unipolar and ground inputs of the Nox A1s recorder.

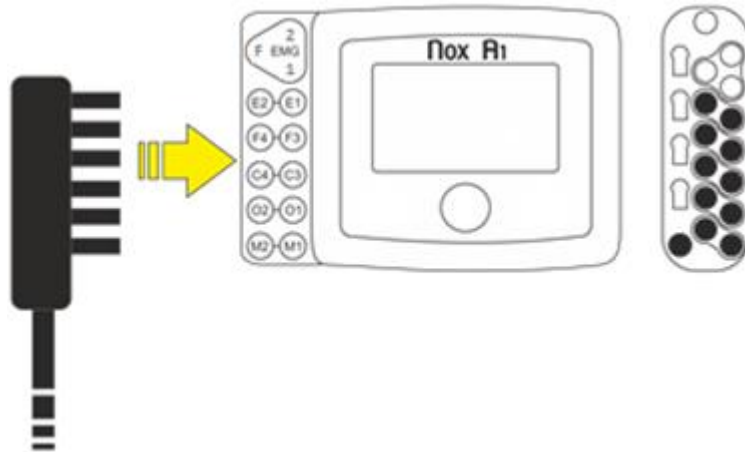

Place a snap-on electrode on the middle of the patient's forehead. Route the Nox A1 EEG Head Cable behind the patient's head and snap the cable to the electrode.

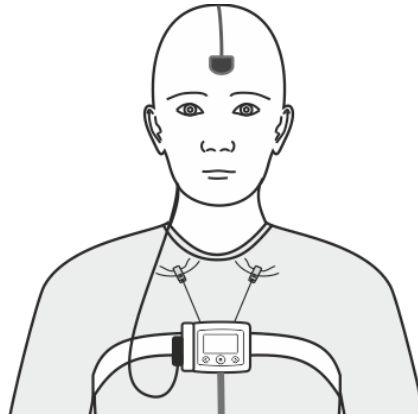

Connect two Nox EEG 5 Lead Gold Electrode Cables to the head cable, one on each side.



Attach the gold cup electrodes to the patient's head. The **green** wire is for **E1/E2**, the **blue** wire is for **F3/F4**, the **yellow** wire is for **C3/C4**, the **grey** wire is for **O1/O2** and the **red** wire is for **M1/M2**. Optionally instead of

using the customized Nox A1s EEG 5 Lead Gold Electrode Cables and Nox A1 EEG Head Cable, eleven standard gold cup electrode leads may be used that connect to the unipolar inputs on the Nox A1s Recorder.

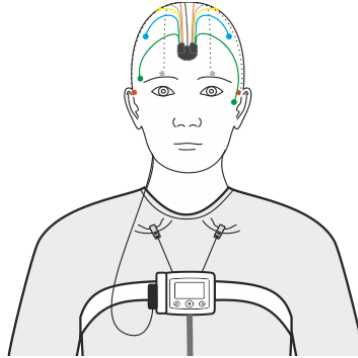

Before electrodes are placed it is important to inspect the skin locations and make sure the electrodes are placed on a dry and clean location that has no abrasions or wounds. To prepare the skin, it is recommended to clean the skin with water and abrasive skin prepping gel. In some cases, if the skin is very oily it can be necessary to use wipes with alcohol. The electrodes are then applied to the skin by use of suitable gel or paste) ensuring biocompatibility and electrical contact. To ensure the proper resistive, cohesive, and adhesive characteristics necessary for accurate recording electrode cream is applied over the surface cup electrodes.

Measuring EMG/ECG Signals



- ▶ Warning: Electrodes should only be used by or in consultation with a healthcare provider familiar with their proper placement and use. Not using and placing the electrodes correctly may affect recording of data, and therefore interpretation and diagnostic.
- ▶ Warning: The electrodes should be applied only to intact, clean skin (e.g. not over open wounds, lesions, infected or inflamed areas) to prevent infections.
- ▶ Warning: Make sure the conductive parts of electrodes and associated connectors, including the neutral electrode, do not contact other conductive parts including earth to prevent potential serious harm to the operator/patient.

The Nox A1s recorder is equipped with 4 bipolar channels suitable for recording of ECG and EMG signals such as leg EMG or masseter EMG for possible bruxism-related event detection. The bipolar channels are labeled with GP1, ECG, LM1, and LM2 and connect to bipolar electrode leads with keyhole connectors (Nox Snap On Double Leads) that snap on to surface electrodes. However, during recording setup, those channels can be defined for any EMG/ECG signals or for supported respiratory flow/pneumoflow sensor. Please refer to the Noxturnal manual for more information on how to configure the Nox A1s recorder.

The figure below shows connections for ECG, EMG on right leg and EMG on left leg. When not using the Nox A1s EEG head cable you can connect your ground electrode to the PGND input on the device.

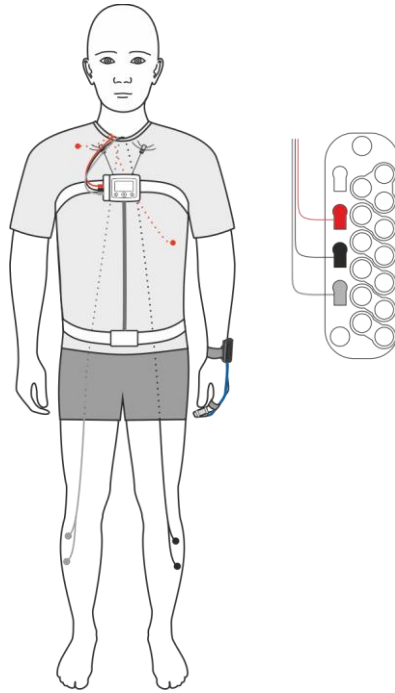

For submental EMG, insert the electrode leads into the EMG channels of the Nox A1s recorder and attach the electrodes to the patient's chin. The front chin electrode goes into the **F** input, the left chin electrode goes into the **1** input, and the right chin electrode goes into the **2** input.

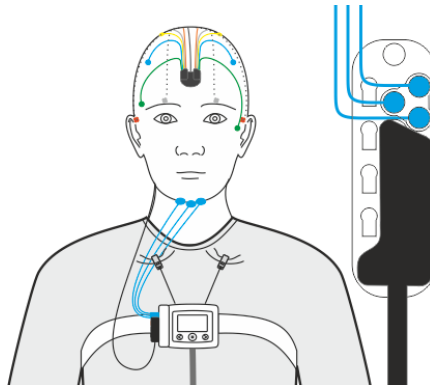

Before electrodes are placed it is important to inspect the skin locations and make sure the electrodes are placed on a dry and clean location that has no small abrasions and wounds. To prepare the skin, it is recommended to clean the skin with water and abrasive skin prepping gel. In some cases, if the skin is very oily it can be necessary to use wipes with alcohol. The electrodes are then applied to the skin by use of suitable gel or paste ensuring biocompatibility and electrical contact.

Measuring Pulse and Oxygen Saturation using Nonin WristOx2 Pulse Oximeter, Model 3150 BLE



- ▶ Warning: The Nox Sleep System is **NOT certified to be used for continuous monitoring** where failure to operate can cause injuries or death of the patient.
- ▶ Warning: Avoid excessive pressure to the sensor application site as this may cause damage to the skin beneath the sensor.

- ▶ Warning: To prevent improper performance and/or patient injury, verify compatibility of the Nox A1s recorder, oximeter, sensor(s), and accessories before use.
- ▶ Warning: Before changing the batteries, make sure the oximeter is off and the sensor is not applied to a digit.
- ▶ Caution: The oximeter has motion tolerant software that minimizes the likelihood of motion artifact being misinterpreted as good pulse quality. In some circumstances, however, the device may still interpret motion as good pulse quality.
- ▶ Caution: To avoid the risk of confusing or misinterpreting patient data when transmitting data via Bluetooth, verify that the oximeter is paired with the correct Nox A1s recorder.
- ▶ Caution: Do not fasten the pulse oximeter too tightly around the patient's wrist. Inaccurate readings and patient discomfort could result.
- ▶ Caution: Do not use a damaged sensor. If the sensor is damaged in any way, discontinue use immediately and replace the sensor.
- ▶ Caution: The oximeter is designed to determine the percentage of arterial oxygen saturation of functional hemoglobin. Factors that may degrade pulse oximeter performance or affect the accuracy of the measurement include the following:
 - excessive ambient light
 - excessive motion
 - electrosurgical interference
 - blood flow restrictors (arterial catheter, blood pressure cuffs, infusion lines, etc.)
 - moisture in the sensor
 - improperly applied sensor
 - incorrect sensor type
 - poor pulse quality
 - venous pulsations
 - anemia or low hemoglobin concentrations
 - cardiogreen and other cardiovascular dyes
 - carboxyhemoglobin
 - methemoglobin
 - dysfunctional hemoglobin
 - artificial nails or fingernail polish
 - residue (e.g., dried blood, dirt, grease, oil) in the light path
- ▶ Caution: When using the oximeter in the home, avoid exposing it to lint and dust.
- ▶ Caution: The pulse oximeter may not work when circulation is reduced. Warm or rub the finger or reposition the sensor.
- ▶ Note: Refer to 3rd party instructions for use accompanying the pulse oximeter and/or oximeter sensor for maximum oximeter application time at a single site.

- ▶ Note: Refer to 3rd party instructions for use accompanying the pulse oximeter and oximeter sensor for additional warnings and cautions.
- ▶ Warning: The Nonin wrist band is single patient use only. The wrist band may be cleaned, refer to 3rd party instructions for use accompanying the pulse oximeter for cleaning instructions, but after cleaning the wrist band should only be applied to the same patient, not to a different patient.

The Nox A1s recorder can communicate with an auxiliary Bluetooth® pulse oximeter for recording of oxygen saturation levels (SpO₂), pulse rate, and plethysmography data.

Refer to the “Compatible Sensors and Devices” section regarding the types of pulse oximeters and sensors that are supported by the Nox Sleep System.

Inserting Batteries into the Nonin WristOx2 Pulse Oximeter, Model 3150 BLE

Refer to the 3rd party accompanying instructions regarding replacement of batteries when using the Nonin WristOx2 Pulse Oximeter, Model 3150.



- ▶ Note: Single use batteries last up to 48 hours of use, so it is important to track the number of measurements made with the Nonin 3150 pulse oximeter. It is recommended to change the batteries after 2-3 recordings depending on the quality of the batteries being used.
- ▶ Note: If you are using rechargeable batteries, it is recommended that you replace them before every recording.

Selecting Oximeter Sensor Size

Reusable Nonin WristOx2 Soft Sensor

Soft sensor size recommendations are based on digit height (thickness). The digit height (H) is measured as shown in the figure below.

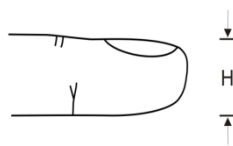

For digit height from 7.5 mm (0.3 in) to 12.5 mm (0.5 in), size small should be selected.

For digit height from 10.5 mm (0.4 in) to 19.0 mm (0.75 in), size medium should be selected.

For digit height from 12.5 mm (0.5 in) to 25.5 mm (1.0 in), size large should be selected.

Attaching the Nonin WristOx2 Pulse Oximeter, Model 3150 BLE and Nonin WristOx2 Soft Sensor

The Nonin 3150 WristOx₂ Oximeter package accompanying the Nox A1s system kits includes:

- WristOx₂® Model 3150 BLE pulse oximeter
- Model 8000SM-WO2, Nonin WristOx2 Soft Sensor
- 1 wrist band

- CD – ROM of the Operator’s manual

Step 1 to Step 4

1. Separate the short end of the wristband from the long end.
2. Insert the short end in the loops on the oximeter.
3. Place the probe wire between the short and long end of the wristband. Attach the long end to the short end to secure the wristband on the oximeter.
4. The oximeter is now securely placed on the wristband and the probe wiring is secured between the two ends, forming a loop that prevents direct pulling of the connector.

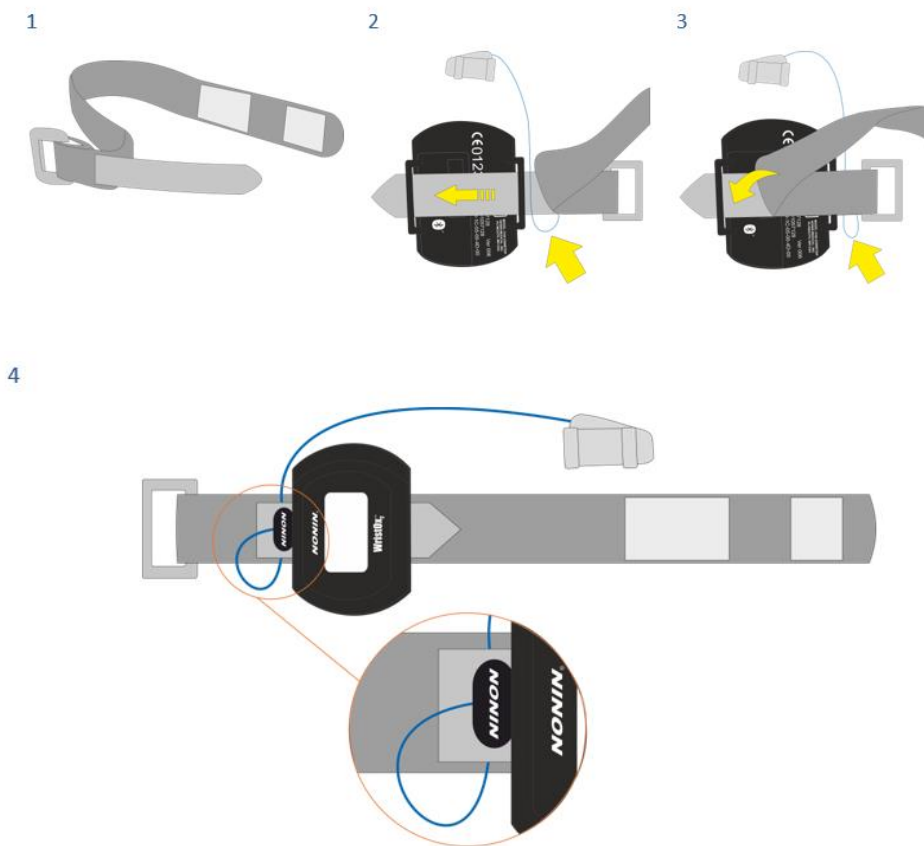

Step 5 to Step 6



- ▶ Note: To prevent the oximeter sensor from falling off, secure its cable with medical tape.

5. Place the wristband around the patient’s wrist.
6. Put the probe on the finger.

5



6

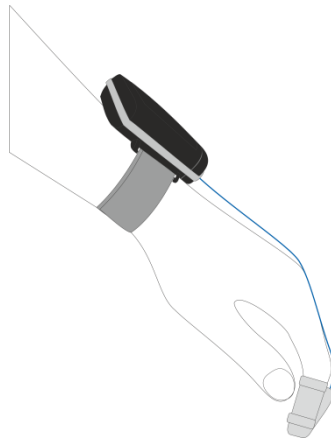
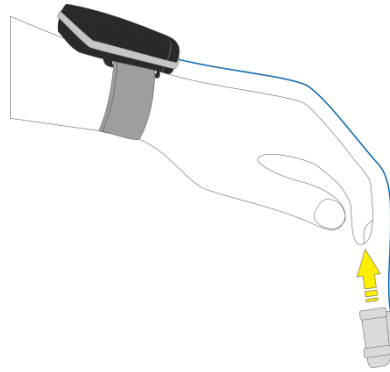

Establishing a Connection between the Nonin 3150 BLE Pulse Oximeter and Nox A1s

Ambulatory studies

Before you can send out the Nox A1s recorder and accessories for an ambulatory recording, you need to make sure that a connection has been established between the Nox A1s recorder and the oximeter. The pairing of the Nox A1s recorder and the oximeter is done during the configuration of the device in the Noxturnal software. Follow the instructions below in order to establish a successful connection between the Nox A1s recorder and the Nonin 3150 BLE oximeter.



Note: The Nox A1s recorder will only connect to Nonin 3150 BLE oximeters and does not support connecting to the Nonin 3150 Classic oximeters. Refer to the Nox Medical support page for further information.

Pairing Process

Step 1. Inserting Batteries

Start by inserting fresh/fully charged batteries in the Nonin 3150 BLE pulse oximeter.

Step 2. Turning on the Nonin 3150 BLE Pulse Oximeter

Turn on the Nonin 3150 BLE pulse oximeter by pressing the gray activation button (red circle on the picture below) on top of the device and you will see the display turn on.



Step 3. Connect the Nox A1s recorder with a USB cable and follow the configuration in Noxturnal

Fill in the BDA number of the pulse oximeter found on the back of the Nonin 3150 BLE oximeter

Nox A1 Configuration ×

Recording Type

1

2

3

Recording Type
Schedule Recording
Patient Information

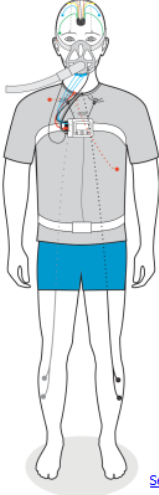

[See channels:](#)

Recording Type:
Standard PSG ⓘ

Other Devices:

Nonin 3150 BLE Oximeter

BDA: 08:6B:D7:1F:AD:F4

Pair with Oximeter

Make sure the oximeter is turned on by pressing the button on top of the device.

Next >
Finish
Cancel



Click Pair with Oximeter and the pairing will be performed either result in a successful pairing

Nox A1 Configuration ×

1
2
3

Recording Type
Schedule Recording
Patient Information

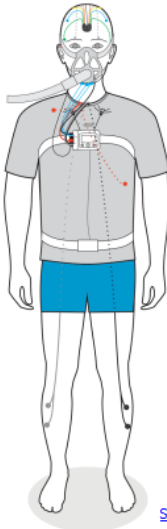

[See channels:](#)

Recording Type:
Standard PSG ⓘ

Other Devices:

Nonin 3150 BLE Oximeter
 BDA: 08:6B:D7:1F:AD:F4
Pair with Oximeter

✔ Oximeter configuration successful.

Next >
Finish
Cancel

Or an unsuccessful pairing

Nox A1 Configuration ×

1
2
3

Recording Type
Schedule Recording
Patient Information

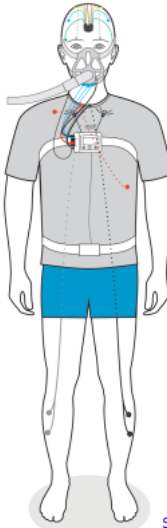

[See channels:](#)

Recording Type:
Standard PSG ⓘ

Other Devices:

Nonin 3150 BLE Oximeter
 BDA: 08:6B:D7:1F:AD:F4
Pair with Oximeter

✘ Failed to configure oximeter.
Make sure the oximeter is turned on by pressing the button on top of the device.

Next >
Finish
Cancel

If not successful follow the troubleshooting tip in the software or see the troubleshooting tips below

Step 4. Bluetooth Wake up mode.

If the pairing was successful during the configuration step in Noxturnal the Nonin 3150 BLE has been put into Bluetooth Wake up Mode. That is indicated by the Bluetooth symbol blinking on regular time interval of the study.



The Nonin 3150 BLE will then turn on when the Nox A1s recorder starts a study (either manual start or scheduled start)

Now the Nox A1s is ready to be packed and handed over/shipped to customer for an ambulatory study

Online Studies

Verify the connection status by:

- Seeing the checkmark on the Nox A1s recorder screen indicating a successful connection to the Nonin 3150 BLE pulse oximeter.



- And/or look at the Nonin 3150 Pulse oximeter and check the following
 - a. The Bluetooth® indicator displays with animated bars when the Bluetooth connection is established.
 - b. The Bluetooth indicator displays without animated bars when the connection is NOT established.

a



b



Troubleshooting Tips

Troubleshooting during oximeter pairing in Noxturnal for ambulatory studies

Incorrect BDA number:

If failing, check the BDA number of the device and make sure it matches the number on the Nonin 3150 BLE oximeter.



Correct BDA number but devices not pairing

- a) Restart the oximeter by removing the batteries and inserting batteries again to the oximeter. Then hold the grey activation button on to turn on the device. Resume the pairing process from Step 3 above or
- b) Restart the Nox A1s by unplugging the Nox A1s from the computer and plugging it back in again. Resume the pairing process from Step 3 above.



Note: This pairing only works for Nonin 3150 BLE oximeters and is not supported with Nonin 3150 Classic oximeters. Refer to the Nox Medical support page for further information.

Note: If this happens repeatedly, it might be necessary to send the oximeter in for service.

Troubleshooting of oximeter connection during hook-up (after successful pairing in Noxturnal) or during online studies

Verify that the BDA number of the oximeter used matches the number used to configure the Nox A1s Recorder. The BDA number used in configuration of the Nox A1s can be found on in the display of the device that shows the status of the oximeter connection. The oximeter BDA number is displayed on the back of the oximeter.



In the case of the number on the device does not match the number of the oximeter it is necessary to re-configure the Nox A1s in Noxturnal and insert there the correct BDA number as in step 3 of the pairing

Correct BDA number but oximeter still marked with “x” on status display:



This means that the Nox A1s recorder and the oximeter are not pairing as expected. To resolve try the following:

- c) Restart the oximeter by removing the batteries and inserting batteries again to the oximeter. Then hold the grey activation button to turn on the oximeter.
- d) Reboot the Nox A1s recorder by simply waiting for the Nox A1s to turn off (it turns off automatically in 2 minutes after it has been turned on) and then, turn on the Nox A1s again by pushing the button or removing and re-inserting the battery.



Note: If this does not solve the issue and this happens repeatedly, it might be necessary to send either A1s or the oximeter in for service.

For further information on troubleshooting refer to the Nox Medical Support Site.

Maintenance

The Nox Sleep System is only intended to be maintained by professionals (healthcare professionals and service personnel) with relevant qualifications and skills.

The Nox A1s recorder and accessories should be stored in a clean, dry place.

Handle the Nox A1s recorder with care and protect it against mechanical shocks, dirt, and liquids. The device is not waterproof or splash proof.

To update the Nox A1s recorder you will need the Noxturnal software running on the computer which the device is connected to. Please refer to the Noxturnal manual for more information on how to perform this task.

No regular testing of the Nox A1s recorder or accessories, including patient cables, is needed.

The service life of the Nox A1s recorder and Nox A1s carry case is 5 years or the equivalent of 1000 studies in total, given that 200 studies are performed in a year. The service life of Nox A1 EEG Head Cable is 1 year, or 200 studies, and the service life of Nox EEG 5 Lead Gold Electrode Cable is 6 months or 100 studies.

The service life is dependent on full compliance with the direction for use given in this manual.



- ▶ **Warning:** Remove batteries from the Nox A1s recorder if it is not used within 30 days to prevent damage from possible battery leakage and prevent possible minor burns to the operator/patient.
- ▶ **Warning:** There are no user serviceable parts inside the Nox A1s recorder. The device should be serviced by authorized parties only. Service performed by non-authorized parties may affect data analysis and result in possible incorrect treatment. The warranty is void if the Nox A1s recorder is opened (except for opening of the battery compartment).
- ▶ **Warning:** No modification of the Nox A1s recorder and its accessories is allowed. Un-authorized modifications could result in the device not performing as intended and cause serious harm to the patient.
- ▶ **Note:** The Nox A1s recorder has an internal battery which is automatically charged by regular use. It is recommended to charge the internal battery before the first use or if the device has not been in use for three months or more. The battery is charged by plugging the Nox A1s recorder to a computer with a USB cable for 6 hours or more.
- ▶ **Note:** It is never recommended to downgrade the firmware of the Nox A1s recorder. Downgrading the firmware will result in losing the calibration for the device: calibration values will be replaced with default values that might affect the pressure and impedance signals being recorded. Only upgrade the firmware of the Nox A1s recorder with firmware files that come directly from Nox Medical

Environmental Conditions

| | |
|-------------------|--|
| Temperature | Operation: +5°C to +40°C (+41°F to +104°F) Transport/Storage: -25°C to +70°C (-13°F to 158°F) |
| Relative Humidity | Operation: 15-90% (non-condensing) Transport/Storage: 10-95% (non-condensing) |
| Pressure | Withstands atmospheric pressures from 700 hPa to 1060 hPa |

Calibration

The Nox A1s recorder is factory calibrated. No further calibration is needed.

Cleaning of Nox A1s Recorder and its Accessories



- ▶ **Warning:** The Nox A1s recorder is not designed to give a specified degree of protection against harmful ingress of liquids. Do not autoclave or immerse the device, nor any sensor, in any kind of liquids. Ingress of liquids may result in electric shock.
- ▶ **Note:** Clean the Nox A1s recorder separately from its associated sensors.
- ▶ **Note:** The Nox A1s recorder components are NOT intended to be sterilized.
- ▶ **Note:** Reusing single-use products on more than one patient poses a risk of cross-infection.
- ▶ **Note:** Regarding cleaning/disinfection and re-use of 3rd party components and 3rd party sensors refer to the applicable 3rd party accompanying instructions.
- ▶ **Note:** Incorrect cleaning of the Nox Sleep System's reusable components can result in contamination and/or biologic risk to patient or clinician.
- ▶ **Note:** Soiled towelettes/cloths should be disposed of as biohazard material in accordance with federal, state, and local regulations.
- ▶ **Note:** Do not soak gold cup electrodes in bleach or alcohol
- ▶ **Note:** Do not use an abrasive-based cleaner on the electrodes, as it can damage the gold plating
- ▶ **Note:** Only apply light force when cleaning gold plated surfaces. Gold plating is soft and can easily be damaged or scratched when contacted.
- ▶ **Note:** Do not rub the gold-plated electrodes with the disinfection wipes
- ▶ **Note:** Do not disinfect the gold-plated electrodes with bleach

All reusable components should be cleaned immediately after use to prevent accumulation of residual soil and minimize soil transfer between patients.

Nox A1s Recorder, Nox Snap On Double Leads, Nox USBc Cable, Nox Abdomen Cable, Nox A1 EEG Head Cable, Nox A1s Carry Case:

MATERIALS/EQUIPMENT:

- Endozime® AW Plus or equivalent validated hospital cleaner**
- Lint-free cloths
- Gloves
- Soft bristle nylon brush (i.e. electrode brush, toothbrush, or nail brush)
- Super Sani-Cloth Plus Disinfection Wipes or equivalent validated disinfectant*

CLEANING/DISINFECTING PROCEDURE:

1. Prepare a solution with the Endozime® AW Plus hospital grade cleaner
 - Follow the instructions accompanying the hospital grade cleaner
2. Dampen a lint-free cloth with the solution
 - Do not pour or spray any liquids on the Nox A1s Recorder
 - Do not allow any liquids to enter any openings on the Nox A1s Recorder
 - Do not immerse the cables in liquid
 - Avoid contact of the cleaning solution to cable/electrode connectors
3. Wipe all surface areas thoroughly to remove all visible soil and contaminants. Wipe the component for at least 2 minutes. Use a soft bristle nylon brush if necessary.
4. Visually inspect the cleaned components to ensure no soil remains. Pay good attention to all junctions and details. Repeat steps 2 and 3 if necessary.
5. Allow components to air dry completely before disinfection (minimum of 3 minutes)
6. For disinfection, take a new wipe of Super Sani-Cloth Plus Disinfection Wipes or equivalent validated disinfectant*
7. Wipe all surface areas of the component with the disinfectant for at least three minutes
 - If other disinfection materials are used than Super Sani-Cloth Plus Disinfection Wipes make sure:
 - they are safe to use on metals and plastics
 - to read the instructions from the manufacturer regarding required contact time of the solution to provide sufficient disinfection
8. Allow components to air dry completely before next use (minimum 1 minute)
9. Visually inspect the components under adequate lighting conditions (and magnification if needed) to confirm that the cleaning/disinfection process has not damaged components. Inspect for surface wear, discoloration, corrosion, or cracking. ***

If necessary, the clips on the Nox A1s recorder can be removed before cleaning. The cleaning process described above also applies for the clips. If the clips are visibly contaminated, they should be replaced.

Nox Gold Cup Electrodes and leads

Clean the gold cup electrodes immediately after use.

MATERIALS/EQUIPMENT:

- Lint-free cloths
- Gloves
- Soft bristle brush (i.e. electrode brush, toothbrush, or nailbrush)
- Q-Tip
- Bowl or a cup
- Super Sani-Cloth Plus Disinfection Wipes or equivalent validated disinfectant*
- Warm water

CLEANING PROCESS:

1. Soak the electrodes (not the connectors) in warm water (55-65°C/131-149°F) for minimum 5 minutes to soften dried electrode paste
 - Do not soak the electrodes in alcohol or bleach
 - Do not use an abrasive-based cleaner on the electrodes, as it can damage the gold plating
2. Use a lint-free cloth, soft bristle brush or a Q-tip to remove all traces of electrode paste from the electrodes
 - Only apply light force when cleaning gold plated surfaces. Gold plating is soft and can easily be damaged or scratched when contacted.
3. Allow the Gold Cup Electrodes to air dry completely (minimum 3 minutes)
4. For disinfection use a fresh wipe of Super Sani-Cloth Plus Disinfection Wipes or equivalent validated disinfectant*. Wipe the electrodes and leads gently for 3 minutes
 - Do not rub the electrodes with the disinfection wipes
 - Do not disinfect the electrodes with bleach
 - If other disinfection wipes are used make sure:
 - they are safe to use on gold plating, metals, and plastics
 - to read the instructions from the manufacturer regarding required contact time of the solution to provide sufficient disinfection
5. Allow the Gold Cup Electrodes to air dry completely (minimum 1 minute)
6. Visually inspect the Gold Cup Electrodes under adequate lighting conditions (and magnification if needed) to confirm that the cleaning/disinfection process has not damaged components. Inspect for surface wear, discoloration, corrosion, or cracking. ***

* Super Sani-Cloth Plus Disinfection Wipes and Sani-Cloth AF Universal - Alcohol free Disinfection wipes (from PDI) are validated disinfectant and recommended to use with the Nox Sleep System. Equivalent validated disinfectant may be used if they are safe to use on gold plating, metals, and plastics.

** Aniosurf ND Premium is a validated hospital cleaner and recommended to use with the Nox Sleep System.

*** If any component damage occurs during cleaning process, contact Nox Medical immediately at support@noxmedical.com. Do not attempt to use the Nox Sleep System until the device has been inspected and repaired by authorized Nox Medical personnel.

The Nox disposable RIP belts are single patient use ONLY.

The Nox nasal cannulas and filter tube connectors are single patient use ONLY.

Disposal

Follow local governing ordinances and recycling instructions regarding disposal or recycling of this device and accessories, including batteries.



- ▶ In compliance with the European Directive on Waste of Electrical and Electronic Equipment (WEEE) 2002/96/EC, do not dispose of this product as unsorted municipal waste. For proper treatment, recovery and recycling, please dispose this product to designated municipal recycling center where it will be accepted free of charge.
- ▶ Disposing of this product correctly will help save valuable resources and prevent any potential negative effects on human health and the environment, which could otherwise arise from inappropriate waste handling.
- ▶ Note: Please contact your distributor regarding take-back or recycling of the components.

Compatible Sensors and Devices



- ▶ **Warning:** No modification of the Nox A1s recorder and its accessories is allowed. Un-authorized modifications could result in the device not performing as intended and cause serious harm to the patient. To ensure patient safety and effective use of the Nox Sleep System, only use accessories that have been validated for use by Nox Medical.

The following table includes information on accessories, sensors and devices that have been validated with the Nox A1s recorder.

The items listed below are Nox products and have been validated for use with the Nox A1s recorder:

NOX DISPOSABLE RIP BELTS

| Type | Catalog Number |
|---|----------------|
| Nox RIP Belts Disposable, Extra Large 14 sets | 551050 |
| Nox RIP Belts Disposable, Large 20 sets | 551040 |
| Nox RIP Belts Disposable, Medium 20 sets | 551030 |
| Nox RIP Belts Disposable, Small 20 sets | 551020 |
| Nox RIP Belts Disposable, Pediatric 20 sets | 551010 |

NOX NASAL CANNULAS/FILTER TUBE CONNECTORS

| Type | Catalog Number |
|-------------------------------------|----------------|
| Nox Cannula with filter, 40 units | 552010 |
| Nox Filter Tube Connector, 50 units | 552110 |

NOX SLEEP SYSTEM COMPONENTS

| Type | Catalog Number |
|------------------------------------|----------------|
| Nox Abdomen Cable, s | 561212 |
| Nox A1 EEG Head Cable, Adult 90 cm | 562110 |
| Nox A1 EEG 5 Lead Electrode Cable | 554411 |
| Nox Carry Case, s | 568012 |
| Nox Service Kit, s | 569015 |
| Nox Battery Lid, s | 569020 |
| Nox Clip Strap, s | 569021 |

| | |
|---------------------|--------|
| Nox Battery Lid Key | 569014 |
| Nox C1 Access Point | 544020 |
| Noxturnal | NA |
| Noxturnal App | 536210 |
| Noxturnal CD | 539010 |

NOX SNAP-ON LEADS

| Type | Catalogue Number |
|---|------------------|
| Nox Snap on Lead, 100cm (20in), Green, 1 unit | 554022 |
| Nox Snap on Lead, Beige – Green, 1 unit | 550423 |
| Nox Snap On Double-Lead 50/100 cm, orange, keyhole connector, 1 unit | 554310 |
| Nox Snap On Double-Lead 30/50 cm, beige-orange, keyhole connector, 1 unit | 554311 |
| Nox Snap On Double-Lead 148/150 cm, grey, keyhole connector, 1 unit | 554312 |
| Nox Snap On Double-Lead 98/100 cm, beige-grey, keyhole connector, 1 unit | 554313 |
| Nox Snap On Double-Lead 148/150 cm, black, keyhole connector, 1 unit | 554314 |
| Nox Snap On Double-Lead 98/100 cm, beige-black, keyhole connector, 1 unit | 554315 |
| Nox Snap On Double-Lead 50/52 cm, white, keyhole connector, 1 unit | 554316 |
| Nox Snap On Double-Lead 30/32 cm, beige-white, keyhole connector, 1 unit | 554317 |

The items listed below are 3rd party products and have been validated for use with the Nox A1s recorder:

PULSE OXIMETERS

| Type | Catalogue Number |
|---|------------------|
| Nonin WristOx ₂ Pulse Oximeter, Model 3150 BLE | 541012 |

PULSE OXIMETER ACCESSORIES

| Type | Catalogue Number |
|---|------------------|
| NONIN WristOx ₂ Soft Sensor – Small | 553010 |
| NONIN WristOx ₂ Soft Sensor – Medium | 553020 |
| NONIN WristOx ₂ Soft Sensor – Large | 553030 |

| | |
|--|--------|
| NONIN WristO ₂ Flex Sensor with 25 Flexi Wraps, 30 cm (12 in) cable – Adult | 553130 |
|--|--------|

| | |
|--------------------------------------|--------|
| NONIN WristO ₂ Wrist Band | 564042 |
|--------------------------------------|--------|

| | |
|--|--------|
| WristO ₂ Wrist Band, Disposable | 560450 |
|--|--------|

THERMAL FLOW SENSORS

| Type | Catalogue Number |
|------|------------------|
|------|------------------|

| | |
|--|--------|
| Thermal Flow Sensor – Adult (S.L.P. Limited) | 552230 |
|--|--------|

MASK PRESSURE TUBING

| Type | Catalogue Number |
|------|------------------|
|------|------------------|

| | |
|--|--------|
| Mask tubing (Westmed) 183cm (72in) Male x Female, 50 units | 552320 |
|--|--------|

ELECTRODES

| Type | Catalogue Number |
|------|------------------|
|------|------------------|

| | |
|--|--------|
| Lead with Attached Electrode (Ambu) 100 cm, 1.5 mm connector, 10 units | 554109 |
|--|--------|

| | |
|--|--------|
| Lead with Attached Electrode (Ambu) 152 cm, 1.5 mm connector, 10 units | 554110 |
|--|--------|

| | |
|---|--------|
| Lead with Attached Electrode (Ambu) 50 cm, 1,5 mm connector, 12 units | 554111 |
|---|--------|

| | |
|---|--------|
| Snap on Electrode Disposable (Ambu), small 25 units | 554209 |
|---|--------|

| | |
|---|--------|
| Blue Sensor® Snap on Electrode (Ambu), 50 units | 554210 |
|---|--------|

| | |
|--|--------|
| Neuroline Cup Disposable EEG Electrodes, 10 per pack | 554220 |
|--|--------|

ELECTRODE APPLIANCES

| Type | Catalogue Number |
|------|------------------|
|------|------------------|

| | |
|---|--------|
| Nuprep ECG & EEG Abrasive Skin Prepping Gel (Weaver and Company), 4oz (114g), 3 units | 555010 |
|---|--------|

| | |
|--|--------|
| Ten20 Conductive EEG Paste (Weaver and Company), 4oz (114g), 3 units | 555020 |
|--|--------|

| | |
|---|--------|
| Tensive Conductive Adhesive Gel, 12 units | 555031 |
|---|--------|

USB CABLE

| Type | Catalogue Number |
|------|------------------|
|------|------------------|

| | |
|------------------|--------|
| USB Type-C Cable | 562016 |
|------------------|--------|

CLEANING

| Type | Catalogue Number |
|--|-------------------------|
| Super Sani-Cloth Plus Disinfection Wipes | 559010 |
| Sani-Cloth AF Universal - Alcohol free Disinfection wipes from PDI | 559011 |

Specifications

Nox A1s and Accessories

| DESCRIPTION | PROPERTIES |
|----------------------------------|---|
| <u>FUNCTION</u> | |
| Nox A1s Storage Capacity | ▶ 4GByte |
| Nox A1s Recording Time | ▶ 10 hours |
| Nox A1s Internal Channels | ▶ Two RIP Respiratory Effort ▶ Pressure ▶ Respiratory sound/snoring ▶ Four bipolar ▶ Thirteen unipolar ▶ Position ▶ Activity ▶ Light |
| Nox A1s External Channels | ▶ Oximeter data via Bluetooth® |
| <u>PHYSICAL</u> | |
| Nox A1s Dimensions | ▶ 82 mm (3.2") W, 62 mm (2.44") H, 26 mm (1.02") D |
| Nox A1s Weight | ▶ 92 ± 5 g without battery (0.20 lbs ± 0.01 lbs without battery) |
| Nox A1s Bipolar Inputs | ▶ Touch proof 1 mm keyhole connector ▶ Input range ≥ ±1024 mV ▶ Bandwidth: 0-90 Hz (6dB) ▶ Input impedance >5 MΩ ▶ Sampling frequency = 512 kHz ▶ Storage frequency = 200 Hz |
| Nox A1s Unipolar Inputs | ▶ Touch proof DIN 42-802 ▶ Input range ≥ ±3.2 mV ▶ Bandwidth > 0.2 - 90 Hz ▶ Input impedance >5 MΩ ▶ Sampling frequency = 512 kHz ▶ Storage frequency = 200 Hz |
| Nox A1s Pressure Sensor | ▶ Pressure input range: -5 cmH2O - +50 cmH2O ▶ Frequency: DC-80 Hz |

- ▶ Sampling frequency: 200 Hz
 - ▶ Storage frequency: 200 Hz
 - ▶ Proprietary Nox Connector
- Nox A1 EEG Head Cable**
- ▶ Head-end connector: Proprietary Nox Connector
 - ▶ Device-end connector: Proprietary Nox Connector
 - ▶ Lengths: Adults – 90 cm (35.4”), Pediatric – 70 cm (27.6”)
- Nox A1 EEG 5 Lead Electrode Cables**
- ▶ Proprietary Nox Connector
 - ▶ 10 mm (0.39”) diameter cup electrodes
- Nox Abdomen Cable**
- ▶ 50 cm (19.7”) length of cable
- USB-C Cable**
- ▶ Type of USB connector at device end: Type-C
 - ▶ Type of USB connector at PC end: Standard A
- Nox Filter Tube Connector**
- ▶ Hydrophobic filter with female Luer-lock inlet - diameter of 13 mm (0.51 in), with a 0.45 μm filtering capability

POWER

- Nox A1s Power Source**
- ▶ One 1.5 V AA battery
 - ▶ Host PC (data configuration and download)
- Nox A1s Battery Type**
- ▶ Alkaline
 - ▶ Lithium
 - ▶ Rechargeable NiMH Batteries

Nox A1s DISPLAY

- Type**
- ▶ OLED
- Display Dimensions**
- ▶ 19 mm x 35 mm (0.75 in x 1.38 in)
- Resolution**
- ▶ 128 x 64

Nox A1s Transmitter

- Bluetooth® Compliance**
- ▶ Version 5.0
- Operating Frequency**
- ▶ 2.402-2.480 GHz
- Output Power**
- ▶ < 4 dBm (\pm 3dB)
- Network Topology**
- ▶ Point-to-Point: Point-to-Multipoint
- Operation**
- ▶ Scatter-Net Master
- Antenna Type**
- ▶ Internal
- Modulation Type**
- ▶ Frequency Shift Keying/Frequency Hopping Spread Spectrum

Bandwidth ▶ 2 MHz

Nox A1s STORAGE FREQUENCY

Microphone ▶ 8 kHz

SpO2 ▶ 3 Hz

Pleth ▶ 75 Hz

Nox A1s SAMPLING FREQUENCY

Microphone ▶ 1 MHz

SpO2 ▶ 75 Hz

BANDWIDTH

Microphone ▶ Internal 3.5 kHz bandwidth

Material Information

COMPONENT

MATERIAL CONTENT

Nox A1s Recorder

- ▶ Enclosure: 10% glass filled acrylonitrile butadiene styrene (ABS)/ polycarbonate (PC)
- ▶ Screen: Polycarbonate (PC)
- ▶ Proxy: PC/ABS
- ▶ Snaps: Gold plated stainless steel
- ▶ Clips: TPU/TPE and nickel-plated steel

Nox Abdomen Cable

- ▶ Cable wire: Tinsel
- ▶ Cable jacket: PVC
- ▶ Abdomen and thorax plastic enclosures: PC/ABS
- ▶ Snaps: Gold-plated stainless steel
- ▶ Strain relief for device end: TPE
- ▶ Strain relief for belt end: PVC
- ▶ Contact springs in the device end: spring steel

Nox Snap on electrode cables, Bipolar

- ▶ Cable Jacket: PVC
- ▶ Cable wire: Tinsel
- ▶ Connector: Gold-plated spring socket contacts, Riteflex®
- ▶ Snap: Nickel-plated brass socket, Riteflex®

Nox Snap on electrode cables, Unipolar

- ▶ Cable Jacket: PVC
- ▶ Cable wire: Tinsel
- ▶ Connector: Gold-plated spring socket contacts, Riteflex®

- ▶ Snap: Nickel-plated brass socket, Riteflex®
- Nox A1 EEG Head Cable**
 - ▶ Cable Jacket: PVC
 - ▶ Head-end connector: TPE
 - ▶ Device-end connectors: Gold-plated contacts, TPE
 - ▶ USB Micro Connector: gold-plated contacts
 - ▶ Connector Pins at Device End: gold-plated contacts
- Nox A1 EEG 5 Lead Electrode Cables**
 - ▶ Cable Jacket: PVC
 - ▶ USB Micro Connector: gold-plated contacts, TPE
 - ▶ Electrode Cups: Gold-plated silver, TPE overmold
- Nox A1s Carry Case**
 - ▶ External Part: BLK 600D Polyester
 - ▶ Internal Part: PU
 - ▶ Insert: ABS
- Nox Disposable RIP Belts**
 - ▶ Belt Elastic: Polyester/Spandex
 - ▶ Connector: ABS
 - ▶ Belt Wire: Tin plated copper

Nox A1s Battery Information



- ▶ Note: Always use fully charged or fresh batteries for each sleep study to prevent the need for the sleep study to be repeated.
- ▶ Note: All lithium batteries used with the Nox A1s recorder shall be according to the standard IEC 60086-4 Primary batteries - Part 4: Safety of lithium batteries.
- ▶ Note: The recording durations listed below depend on the quality of the batteries used.

The list below is provided to assist the user in selecting the appropriate battery type for the Nox A1s study:

- **Lithium batteries** and **Powerex 2700 mAh rechargeable batteries** should be used to record a minimum of 10 hours.

Regulatory Information

Performance Testing and Validation Summary

The Nox Sleep System has been tested and verified in various phases to include internal testing, verification, and validation as well as external testing to assure product safety, effectiveness, and reliability. The design was verified and validated, including clinical evaluation, throughout the design process, according to requirement specifications and intended use. External accredited test houses were used to conduct testing needed to comply with the applicable standards regarding Electromagnetic Compatibility (EMC) and patient safety as well as additional RF testing to assure compliance with Industry Canada Regulations and Radio Equipment Directive (RED).

The compliance of the Nox Sleep System towards patient safety and medical device standards has ONLY been verified and validated with the sensors and accessories listed in this manual. This includes all signal characteristics and automatic analysis provided by the Nox Sleep System.

Furthermore, use of other sensors or accessories with the Nox A1s recorder invalidates the Declaration of Conformity issued by Nox Medical towards the Medical Devices Directive 93/42/EEC (MDD). Use of other components than verified, validated or recommended by Nox Medical with the Nox A1s recorder is considered to be a modification of the Nox Sleep System. Such modifications could result in the system not performing as intended and cause serious harm to the patient.

Nox Medical holds an ISO 13485:2016 (MDSAP) certified Quality Management System which complies with the requirements of the Medical Device Directive (MDD - Council Directive 93/42/EEC as amended by Directive 2007/47/EC); Canada – Medical Devices Regulations – Part 1 – SOR 98/282; Australia – Therapeutic Goods (Medical Devices) Regulations, 2002, Schedule 3 Part 1 (excluding Part 1.6) – Full Quality Assurance Procedure; Japan – MHLW Ministerial Ordinance 169, Article 4 to Article 68; PMD Act and USA – 21 CFR 820, 21 CFR 803, 21 CFR 806, 21 CFR 807 – Subparts A to D.

Nox A1s Classifications



- ▶ Degree of protection (applied part) against electric shock: The entire device is an applied part and is classified as of **type BF** (see symbol to the left).
- ▶ Powering of the device: The device is **internally powered**.
- ▶ Degree of protection against harmful ingress of liquids and particulate matter:
 - **The Nox A1s recorder is classified IP22**, i.e. as defined by the standard IEC 60529 it is protected against solid foreign objects of 12.5 mm diameter and greater and vertically falling water drops when enclosure tilted up to 15°. It is not protected against spraying or splashing of water.
- ▶ Method of sterilization: The device is **NOT delivered sterile or intended to be sterilized**.
- ▶ Suitability for use in an oxygen rich environment: The device is **NOT intended for use in an oxygen rich environment**.
- ▶ Suitability for use with flammable agents and anesthetics: The device is **NOT intended for use in conjunction with flammable agents or with flammable anesthetic mixture with air or with oxygen or nitrous oxide**.
- ▶ Mode of operation: The device is intended for **continuous operation**.

Description of Symbols and Labels



- ▶ Operating instructions / Consult instructions for use



- ▶ Manufacturer information



- ▶ Date of manufacture



- ▶ Do not re-use



- ▶ Serial number



- ▶ Batch code / Lot number



- ▶ Catalogue number / Reference number

(01)1569431111XXXX(11)YYMMDD
(21)WWWWWWWWW

(01)1569431111XXXX(11)YYMMDD
(10)ZZZZZZ

- ▶ Unique Device Identifier (UDI); the Application Identifier (01) represents the device identifier (DI) (“1569431111XXXX”), the Application Identifier (11) the production date/date of manufacture (“YYMMDD”, with “YY” the last two digits of the production year, “MM” the production month and “DD” the production day), the Application Identifier (21) the serial number of the device (“WWWWWWWWW”) if applicable, and the Application Identifier (10)ZZZZZZ the lot number of the device (“ZZZZZZ”) if applicable



- ▶ Unique Device Identifier (UDI) presented in data matrix format



- ▶ RFID containing UDI information



- ▶ Type BF applied part (patient isolation from electrical shock)



- ▶ In compliance with the European Directive on Waste of Electrical and Electronic Equipment (WEEE) 2002/96/EC, do not dispose of this product as unsorted municipal waste. For proper treatment, recovery and recycling, please dispose this product to designated municipal recycling center where it will be accepted free of charge.



CE2797, CE

Nox A1s

APSG1SEU

Contains IC: 25077-NOXBLEMOD

REV

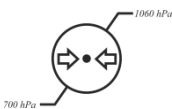
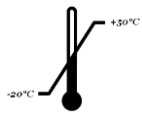

IPN₁N₂



- ▶ Disposing of this product correctly will help save valuable resources and prevent any potential negative effects on human health and the environment, which could otherwise arise from inappropriate waste handling.
- ▶ Non-ionizing radiation. Equipment includes RF transmitter: interference may occur in the vicinity of equipment marked with this symbol
- ▶ CE marking indicating conformance to the applicable EU regulations/directives
- ▶ Brand name/Model name
- ▶ Technical name
- ▶ Industry Canada (IC) label
- ▶ Revision of device
- ▶ Bluetooth® wireless technology
- ▶ Temperature limit
- ▶ Humidity limitation
- ▶ Atmospheric pressure limitation
- ▶ Keep dry
- ▶ Fragile, handle with care
- ▶ Degree of protection against harmful ingress of water or particulate matter as defined by the standard IEC 60529, where N₁ defines the degree of protection against harmful ingress of particulate matter and N₂ the degree of protection against harmful ingress of water
- ▶ Unsafe for MR (Magnetic Resonance) Environment.



▶ Medical Device

Bluetooth® Wireless Technology

The Nox A1s recorder uses Bluetooth® 5.0 wireless technology to communicate with external Bluetooth modules.

The Bluetooth wireless technology is based on a radio link that offers fast and reliable transmission of data. Bluetooth radio uses globally available frequency range in the industrial, scientific and medical (ISM) band, intended to ensure communication compatibility worldwide and a fast acknowledgement and frequency-hopping scheme to make the link robust, even in noisy radio environments. Please refer to the “Specifications” section for details on Radio Frequency (RF) specifications for the Nox A1s recorder.

The *Bluetooth*® word mark and logos are registered trademarks owned by the Bluetooth SIG, Inc. and any use of such marks by Nox Medical is under license. Other trademarks and trade names are those of their respective owners.

Electromagnetic Compatibility (EMC) Information



- ▶ Caution: Exposure to radio frequency radiation.
- ▶ Note: Portable and mobile Radio Frequency (RF) communications can affect the performance of the Nox A1s recorder.
- ▶ Warning: Portable RF communications equipment (including peripherals such as antenna cables and external antennas) should be used no closer than 30 cm (12 inches) to any part of the Nox Sleep System BLE, including cables specified by the manufacturer. Otherwise, degradation of the performance of this equipment could result.
- ▶ Warning: Electromagnetic interference (EMI) can be picked up by the Nox A1s recorder, causing disturbed or altered signals to appear in the Noxturnal software. This may affect data analysis and result in incorrect interpretation of data.
- ▶ Warning: The Nox A1s recorder(s) should not be used adjacent to or stacked with other equipment. If adjacent or stacked use is necessary, the device(s) should be observed to verify normal operation in the configuration in which it will be used and prevent abnormal operation which might cause injuries to the operator/patient.
- ▶ Warning: The use of accessories, transducers, sensors, and cables other than those listed in this manual may result in increased emissions and/or decreased immunity of the Nox A1s recorder and cause injuries to the operator/patient.
- ▶ Warning: The Nox Sleep System BLE may be interfered with by other equipment, even if that equipment complies with CISPR (Special International Committee on Radio Interference) emission requirements, causing possible patient harm
- ▶ Refer to the tables below in this section for specific information regarding the Nox A1s recorder’s compliance to the standard IEC60601-1-2: Medical electrical equipment - Part 1-2: General requirements for basic safety and essential performance - Collateral Standard: Electromagnetic disturbances - Requirements and tests.

Declarations of Conformity with the Industry Canada (IC) Regulations

This device complies with Industry Canada license-exempt RSS standard(s). Operation is subject to the following two conditions:

(1) this device may not cause interference, and

(2) this device must accept any interference, including interference that may cause undesired operation of the device.

This device and its antenna(s) must not be co-located with any other transmitters except in accordance with IC multi-transmitter product procedures.

IC Radiation Exposure Statement:

This device complies with the safety requirements for RF exposure in accordance with RSS-102 Issue 5 for portable use conditions.

Compliance to the standard IEC 60601-1-2: Medical electrical equipment - Part 1-2: General requirements for basic safety and essential performance - Collateral Standard: Electromagnetic disturbances - Requirements and Tests.

ELECTROMAGNETIC EMISSIONS

| The Nox A1s recorder is intended for use in the electromagnetic environment specified below. The customer or the user of the device should assure that it is used in such an environment. | | |
|---|-------------------|---|
| Emissions test | Compliance | Electromagnetic environment – guidance |
| RF emissions CISPR 11 | Group 2 | The device must emit electromagnetic energy in order to perform its intended function. Nearby electronic equipment may be affected. |
| RF emissions CISPR 11 | Class B | The device is suitable for use in all establishments, including domestic establishments and those directly connected to the public low-voltage power supply network that supplies buildings used for domestic purposes. |
| Harmonic emissions IEC 61000-3-2 | Not applicable | |
| Voltage fluctuations/ flicker emissions IEC 61000-3-3 | Not applicable | |

ELECTROMAGNETIC IMMUNITY

The A1s recorder is intended for use in the electromagnetic environment specified below. The customer or the user of the device should assure that it is used in such an environment.

| Immunity test | IEC 60601 test level | Compliance level |
|--|--|---|
| Electrostatic discharge (ESD) IEC 61000-4-2 | ±8 kV contact ±2 kV, ±4 kV, ±8 kV and ±15 kV air | ±8 kV contact ±2 kV, ±4 kV, ±8 kV and ±15 kV air |
| Electrical fast transient/burst IEC 61000-4-4 | ± 2 kV for power supply lines ± 1 kV for input/output parts port 100 kHz repetition frequency | Not applicable |
| Surge IEC 61000-4-5 | ±0,5 kV, ±1 kV line-to-line ±0,5 kV, ±1 kV, ±2 kV lines-to-ground | Not applicable |
| Voltage dips IEC 61000-4-11 | 0 % U_T for 0,5 cycle at 0°, 45°, 90°, 135°, 180°, 225°, 270° and 315°. 0 % U_T for 1 cycle 70 % U_T for 25/30 cycles | Not applicable |
| Voltage Interruptions IEC 61000-4-11 | 0 % U_T for 250/300 cycles | Not applicable |
| Rated power frequency magnetic field IEC 61000-4-8 | 30 A/m 50 or 60 Hz | 30 A/m 60 Hz |
| Conducted disturbances induced by RF fields IEC 61000-4-6 | 3 V 0,15 MHz to 80 MHz 6 V in ISM and amateur radio bands between 0,15 MHz and 80 MHz 80% AM at 1 kHz | 3 V 0,15 MHz to 80 MHz 6 V in ISM and amateur radio bands between 0,15 MHz and 80 MHz 80% AM at 1 kHz |
| Radiated RF EM fields IEC 61000-4-3 | 3 V/m and 10 V/m 80 MHz to 2.7 GHz 80% AM at 1 kHz | 3 V/m and 10 V/m 80 MHz to 2.7 GHz 80% AM at 1 kHz |
| Proximity fields from RF wireless communications equipment IEC 61000-4-3 | Refer to Immunity to proximity fields from RF wireless communications equipment | Refer to Immunity to proximity fields from RF wireless communications equipment |
| NOTE U_T is the a.c. mains voltage prior to application of the test level. | | |

IMMUNITY TO PROXIMITY FIELDS FROM RF WIRELESS COMMUNICATIONS EQUIPMENT

The A1s recorder is intended for use in the electromagnetic environment specified below. The customer or the user of the device should assure that it is used in such an environment.

| Test Frequency (MHz) | Band (MHz) | Service | Modulation | Maximum power (W) | Distance (m) | Immunity Test Level (V/m) | Compliance (Yes/No) |
|----------------------|------------|---|--------------------------------------|-------------------|--------------|---------------------------|---------------------|
| 385 | 380-390 | TETRA 400 | Pulse modulation 18Hz | 1,8 | 0,3 | 27 | Yes |
| 450 | 430-470 | GMRS 460, FRS 460 | FM ±5 kHz deviation 1 kHz sine | 2 | 0,3 | 28 | Yes |
| 710 | 704-787 | LTE Band 13, 17 | Pulse modulation 217 Hz | 0,2 | 0,3 | 9 | Yes |
| 745 | | | | | | | |
| 780 | | | | | | | |
| 810 | 800-960 | GSM 800/900, TETRA 800, iDEN 820, CDMA 850, LTE Band 5 | Pulse modulation 18 Hz | 2 | 0,3 | 28 | Yes |
| 870 | | | | | | | |
| 930 | | | | | | | |
| 1720 | 1700-1990 | GSM 1800; CDMA 1900; GSM 1900; DECT; LTE Band 1, 3, 4, 25; UMTS | Pulse modulation 217 Hz | 2 | 0,3 | 28 | Yes |
| 1845 | | | | | | | |
| 1970 | | | | | | | |
| 2450 | 2400-2570 | Bluetooth, WLAN, 802.11 b/g/n, RFID 2450, LTE Band 7 | Pulse modulation 217 Hz | 2 | 0,3 | 28 | Yes |
| 5240 | 5100-5800 | WLAN 802.11 a/n | Pulse modulation 217 Hz | 0,2 | 0,3 | 9 | Yes |
| 5500 | | | | | | | |
| 5785 | | | | | | | |

About

This manual and associated translations are provided in electronic format according to Commission Regulation (EU) No 207/2012 of 9 March 2012 on electronic instructions for use of medical devices. They are also available in electronic format on Nox Medical's website: www.noxmedical.com/ifu.

Electronic versions are provided as PDF documents and a PDF reader is required to open the documents. PDF readers are commonly available at no cost for users. Refer to the applicable system and hardware requirements for the PDF reader that is used.

Hard copies can be requested at no additional cost by emailing support@noxmedical.com. The hard copy will be sent within 7 calendar days.